

K.S.M.
springs



Elwell Street T:0121 521 3409 sales@ksmsprings.co.uk
West Bromwich F:0121 520 8201 www.ksmsprings.co.uk
West Midlands, B70 0DW

Springs From Stock



Manufacturers of Springs & Pressings in All Metals

CNC Wire Erosion

CNC Camless Autocoiling

CNC Machining

Flat, Scroll, Constant Force and Volute Springs a Speciality

Presswork to 100 tonnes

**NEW TOOLROOM DIE
SPRING SECTION**

Telephone: 0121 521 3409

Fax: 0121 520 8201

Website: www.ksmsprings.co.uk

Email: sales@ksmsprings.co.uk

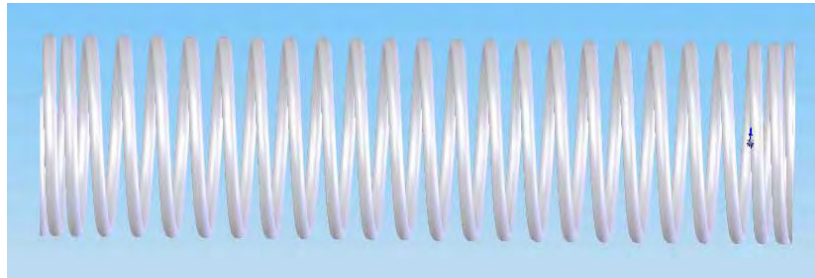

STEEL COMPRESSION SPRINGS

FROM STOCK

When ordering it is necessary to specify the full spring reference number.

See also our range of assorted boxes.

All orders subject to a Carriage Charge

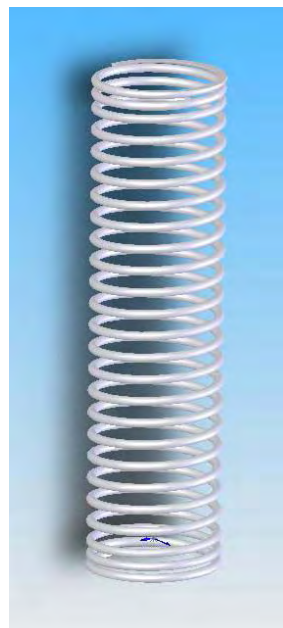

Spring No.	Length		Outside Diameter		Total Coils	Wire Dia			Approx. Solid Load		Solid Height		Spring Rate	
	Ins.	mm	Ins.	mm		SWG	Ins.	mm	lb	kg	Ins	mm	lb/in	N/mm
MSC 89	0.50	13	0.187	4.75	9	26	0.018	0.45	1.5	0.7	0.159	4.05	3.88	0.682
MSC 90	0.75	19	0.187	4.75	13	26	0.018	0.45	1.5	0.7	0.230	5.85	2.53	0.445
MSC 91	1.00	25	0.187	4.75	16.5	26	0.018	0.45	1.5	0.7	0.293	7.43	1.94	0.341
MSC 92	1.50	38	0.187	4.75	24.5	26	0.018	0.45	1.5	0.7	0.434	11.02	1.26	0.222
MSC 93	0.50	13	0.187	4.75	9.5	24	0.022	0.56	3.0	1.4	0.209	5.32	9.43	1.656
MSC 94	0.75	19	0.187	4.75	13.5	24	0.022	0.56	3.0	1.4	0.298	7.56	6.29	1.104
MSC 95	1.00	25	0.187	4.75	17.5	24	0.022	0.56	3.0	1.4	0.386	9.8	4.72	0.828
MSC 96	1.50	38	0.187	4.75	25.5	24	0.022	0.56	3.0	1.4	0.562	14.28	3.14	0.552
MSC 97	0.50	13	0.187	4.75	10	22	0.028	0.71	6.0	2.8	0.280	7.1	25.60	4.494
MSC 98	0.75	19	0.187	4.75	14	22	0.028	0.71	6.0	2.8	0.391	9.94	17.41	3.056
MSC 99	1.00	25	0.187	4.75	18.5	22	0.028	0.71	6.0	2.8	0.517	13.14	12.80	2.247
MSC 100	1.50	38	0.187	4.75	27	22	0.028	0.71	6.0	2.8	0.755	19.17	8.53	1.498
MSC 101	1.00	25	0.25	6.4	12.5	23	0.024	0.61	2.5	1.2	0.300	7.63	3.66	0.643
MSC 102	1.25	32	0.25	6.4	15.5	23	0.024	0.61	2.5	1.2	0.372	9.45	2.88	0.505
MSC 103	1.50	38	0.25	6.4	18	23	0.024	0.61	2.5	1.2	0.432	10.98	2.44	0.429
MSC 104	2.00	51	0.25	6.4	24	23	0.024	0.61	2.5	1.2	0.576	14.64	1.79	0.314
MSC 105	1.00	25	0.25	6.4	14	21	0.032	0.81	6.5	3.0	0.446	11.34	11.13	1.954
MSC 106	1.25	32	0.25	6.4	17.5	21	0.032	0.81	6.5	3.0	0.558	14.18	8.70	1.527
MSC 107	1.50	38	0.25	6.4	20.5	21	0.032	0.81	6.5	3.0	0.654	16.6	7.33	1.286
MSC 108	2.00	51	0.25	6.4	27	21	0.032	0.81	6.5	3.0	0.861	21.87	5.46	0.958
MSC 109	1.00	25	0.25	6.4	15.5	19	0.040	1.0	11	5.0	0.610	15.5	25.62	4.497
MSC 110	1.25	32	0.25	6.4	19	19	0.040	1.0	11	5.0	0.748	19	20.49	3.597
MSC 111	1.50	38	0.25	6.4	22.5	19	0.040	1.0	11	5.0	0.886	22.5	17.08	2.998
MSC 112	2.00	51	0.25	6.4	30	19	0.040	1.0	11	5.0	1.181	30	12.58	2.209

Spring No.	Length		Outside Diameter		Total Coils	Wire Dia			Approx. Solid Load		Solid Height		Spring Rate	
	Ins.	mm	Ins.	mm		SWG	Ins.	mm	lb	kg	Ins	mm	lb/in	N/mm
MSC 113	1.00	25	0.31	8.0	10	22	0.028	0.71	3.5	1.6	0.280	7.1	4.36	0.765
MSC 114	1.25	32	0.31	8.0	12	22	0.028	0.71	3.5	1.6	0.335	8.52	3.53	0.619
MSC 115	1.50	38	0.31	8.0	14	22	0.028	0.71	3.5	1.6	0.391	9.94	2.96	0.520
MSC 116	2.00	51	0.31	8.0	18	22	0.028	0.71	3.5	1.6	0.503	12.78	2.24	0.394
MSC 117	1.00	25	0.31	8.0	11.5	20	0.036	0.91	7	3.2	0.412	10.47	10.86	1.907
MSC 118	1.25	32	0.31	8.0	13.5	20	0.036	0.91	7	3.2	0.483	12.28	9.05	1.589
MSC 119	1.50	38	0.31	8.0	16	20	0.036	0.91	7	3.2	0.573	14.56	7.49	1.315
MSC 120	2.00	51	0.31	8.0	21	20	0.036	0.91	7	3.2	0.752	19.11	5.57	0.978
MSC 121	1.00	25	0.31	8.0	13	18	0.048	1.2	15	7	0.614	15.6	32.38	5.684
MSC 122	1.25	32	0.31	8.0	15.5	18	0.048	1.2	15	7	0.732	18.6	26.60	4.669
MSC 123	1.50	38	0.31	8.0	18.5	18	0.048	1.2	15	7	0.874	22.2	21.90	3.845
MSC 124	2.00	51	0.31	8.0	24.5	18	0.048	1.2	15	7	1.157	29.4	16.19	2.842
MSC 125	1.00	25	0.38	9.5	8.5	20	0.036	0.91	7	3.2	0.305	7.74	8.73	1.532
MSC 126	1.25	32	0.38	9.5	10.5	20	0.036	0.91	7	3.2	0.376	9.56	6.79	1.192
MSC 127	1.50	38	0.38	9.5	12.5	20	0.036	0.91	7	3.2	0.448	11.38	5.55	0.975
MSC 128	2.00	51	0.38	9.5	15.5	20	0.036	0.91	7	3.2	0.555	14.1	4.36	0.766
MSC 129	1.00	25	0.38	9.5	10	18	0.048	1.2	15	7	0.472	12	24.09	4.229
MSC 130	1.25	32	0.38	9.5	12	18	0.048	1.2	15	7	0.567	14.4	19.50	3.424
MSC 131	1.50	38	0.38	9.5	14.5	18	0.048	1.2	15	7	0.685	17.4	15.75	2.765
MSC 132	2.00	51	0.38	9.5	18.5	18	0.048	1.2	15	7	0.874	22.2	12.05	2.115
MSC 133	1.00	25	0.38	9.5	10.5	16	0.064	1.6	30	14	0.661	16.8	83.39	14.64
MSC 134	1.25	32	0.38	9.5	13	16	0.064	1.6	30	14	0.819	20.8	65.26	11.457
MSC 135	1.50	38	0.38	9.5	15.5	16	0.064	1.6	30	14	0.976	24.8	53.61	9.411
MSC 136	2.00	51	0.38	9.5	20	16	0.064	1.6	30	14	1.260	32	40.57	7.122

Spring No.	Length		Outside Diameter		Total Coils	Wire Dia			Approx. Solid Load		Solid Height		Spring Rate	
	Ins.	mm	Ins.	mm		SWG	Ins.	mm	lb	kg	Ins	mm	lb/in	N/mm
MSC 137	1.00	25	0.44	11	7.5	19	0.040	1.0	7	3.2	0.295	7.5	9.41	1.652
MSC 138	1.25	32	0.44	11	8.5	19	0.040	1.0	7	3.2	0.335	8.5	8.07	1.416
MSC 139	1.50	38	0.44	11	9.5	19	0.040	1.0	7	3.2	0.374	9.5	7.06	1.239
MSC 140	2.00	51	0.44	11	13	19	0.040	1.0	7	3.2	0.512	13	4.91	0.862
MSC 141	2.50	64	0.44	11	17	19	0.040	1.0	7	3.2	0.669	17	3.65	0.64
MSC 142	1.00	25	0.44	11	9	17	0.056	1.4	20	9	0.496	12.6	32.69	5.739
MSC 143	1.25	32	0.44	11	11	17	0.056	1.4	20	9	0.606	15.4	25.81	4.531
MSC 144	1.50	38	0.44	11	13	17	0.056	1.4	20	9	0.717	18.2	21.32	3.743
MSC 145	2.00	51	0.44	11	16	17	0.056	1.4	20	9	0.882	22.4	16.91	2.968
MSC 146	2.50	64	0.44	11	20	17	0.056	1.4	20	9	1.102	28	13.25	2.326
MSC 147	1.00	25	0.44	11	8.5	15	0.072	1.8	40	18	0.602	15.3	108.74	19.09
MSC 148	1.25	32	0.44	11	11	15	0.072	1.8	40	18	0.780	19.8	80.12	14.066
MSC 149	1.50	38	0.44	11	13.5	15	0.072	1.8	40	18	0.957	24.3	63.43	11.136
MSC 150	2.00	51	0.44	11	17.5	15	0.072	1.8	40	18	1.240	31.5	47.57	8.352
MSC 151	2.50	64	0.44	11	21.5	15	0.072	1.8	40	18	1.524	38.7	38.06	6.682
MSC 152	1.25	32	0.50	13	8	18	0.048	1.2	11	5	0.378	9.6	10.97	1.925
MSC 153	1.50	38	0.50	13	9.5	18	0.048	1.2	11	5	0.449	11.4	8.91	1.564
MSC 154	2.00	51	0.50	13	12.5	18	0.048	1.2	11	5	0.591	15	6.48	1.137
MSC 155	2.50	64	0.50	13	15.5	18	0.048	1.2	11	5	0.732	18.6	5.09	0.894
MSC 156	3.00	76	0.50	13	18	18	0.048	1.2	11	5	0.850	21.6	4.32	0.758
MSC 157	1.25	32	0.50	13	9.5	16	0.064	1.6	25	11	0.598	15.2	31.22	5.481
MSC 158	1.50	38	0.50	13	11	16	0.064	1.6	25	11	0.693	17.6	26.29	4.616
MSC 159	2.00	51	0.50	13	14	16	0.064	1.6	25	11	0.882	22.4	19.98	3.508
MSC 160	2.50	64	0.50	13	17	16	0.064	1.6	25	11	1.071	27.2	16.11	2.829
MSC 161	3.00	76	0.50	13	20.5	16	0.064	1.6	25	11	1.291	32.8	13.15	2.308

Spring No.	Length		Outside Diameter		Total Coils	Wire Dia			Approx. Solid Load		Solid Height		Spring Rate	
	Ins.	mm	Ins.	mm		SWG	Ins.	mm	lb	kg	Ins	mm	lb/in	N/mm
MSC 162	1.25	32	0.50	13	10	14	0.080	2.0	45	20	0.787	20	79.86	14.019
MSC 163	1.50	38	0.50	13	12	14	0.080	2.0	45	20	0.945	24	64.64	11.348
MSC 164	2.00	51	0.50	13	15.5	14	0.080	2.0	45	20	1.220	31	48.48	8.511
MSC 165	2.50	64	0.50	13	19	14	0.080	2.0	45	20	1.496	38	38.79	6.809
MSC 166	3.00	76	0.50	13	23	14	0.080	2.0	45	20	1.811	46	31.57	5.542
MSC 167	1.50	38	0.63	16	7.5	17	0.056	1.4	13	6	0.413	10.5	11.61	2.039
MSC 168	2.00	51	0.63	16	10	17	0.056	1.4	13	6	0.551	14	8.20	1.439
MSC 169	2.50	64	0.63	16	12	17	0.056	1.4	13	6	0.661	16.8	6.64	1.165
MSC 170	3.00	76	0.63	16	14.5	17	0.056	1.4	13	6	0.799	20.3	5.36	0.941
MSC 171	3.50	89	0.63	16	16.5	17	0.056	1.4	13	6	0.909	23.1	4.65	0.816
MSC 172	1.50	38	0.63	16	9	15	0.072	1.8	30	14	0.638	16.2	27.60	4.846
MSC 173	2.00	51	0.63	16	11	15	0.072	1.8	30	14	0.780	19.8	21.79	3.826
MSC 174	2.50	64	0.63	16	14	15	0.072	1.8	30	14	0.992	25.2	16.56	2.907
MSC 175	3.00	76	0.63	16	16	15	0.072	1.8	30	14	1.134	28.8	14.27	2.506
MSC 176	3.50	89	0.63	16	19	15	0.072	1.8	30	14	1.346	34.2	11.83	2.077
MSC 177	1.50	38	0.63	16	10	13	0.092	2.3	50	23	0.906	23	72.29	12.691
MSC 178	2.00	51	0.63	16	12.5	13	0.092	2.3	50	23	1.132	28.75	55.86	9.807
MSC 179	2.50	64	0.63	16	15.5	13	0.092	2.3	50	23	1.404	35.65	43.90	7.706
MSC 180	3.00	76	0.63	16	17.5	13	0.092	2.3	50	23	1.585	40.25	38.40	6.742
MSC 181	3.50	89	0.63	16	20.5	13	0.092	2.3	50	23	1.880	47.75	32.34	5.678
MSC 182	2.00	51	0.75	19	8.5	15	0.072	1.8	25	11	0.602	15.3	16.64	2.921
MSC 183	2.50	64	0.75	19	10.5	15	0.072	1.8	25	11	0.744	18.9	12.94	2.272
MSC 184	3.00	76	0.75	19	12.5	15	0.072	1.8	25	11	0.886	22.5	10.59	1.859
MSC 185	3.50	89	0.75	19	14.5	15	0.072	1.8	25	11	1.028	26.1	8.96	1.573
MSC 186	4.00	102	0.75	19	16.5	15	0.072	1.8	25	11	1.169	29.7	7.76	1.363

Spring No.	Length		Outside Diameter		Total Coils	Wire Dia			Approx. Solid Load		Solid Height		Spring Rate	
	Ins.	mm	Ins.	mm		SWG	Ins.	mm	lb	kg	Ins	mm	lb/in	N/mm
MSC 187	2.00	51	0.75	19	10	13	0.092	2.3	50	23	0.906	23	39.91	7.007
MSC 188	2.00	64	0.75	19	12	13	0.092	2.3	50	23	1.087	27.6	32.31	5.672
MSC 189	2.00	76	0.75	19	14	13	0.092	2.3	50	23	1.268	32.2	27.14	4.765
MSC 190	2.00	89	0.75	19	16	13	0.092	2.3	50	23	1.449	36.8	23.40	4.108
MSC 191	2.00	102	0.75	19	18	13	0.092	2.3	50	23	1.630	41.4	20.56	3.61
MSC 192	2.00	51	0.75	19	10.5	11	0.116	2.9	90	41	1.199	30.45	106.33	18.666
MSC 193	2.50	64	0.75	19	13	11	0.116	2.9	90	41	1.484	37.7	83.21	14.608
MSC 194	3.00	76	0.75	19	15.5	11	0.116	2.9	90	41	1.770	44.95	68.35	12
MSC 195	3.50	89	0.75	19	18	11	0.116	2.9	90	41	2.055	52.2	58.00	10.182
MSC 196	4.00	102	0.75	19	20.5	11	0.116	2.9	90	41	2.341	59.45	50.37	8.842
MSC 197	2.00	51	0.88	22	7.5	14	0.080	2.0	25	11	0.591	15	18.82	3.304
MSC 198	2.50	64	0.88	22	9	14	0.080	2.0	25	11	0.709	18	15.06	2.643
MSC 199	3.00	76	0.88	22	10.5	14	0.080	2.0	25	11	0.827	21	12.55	2.203
MSC 200	3.50	89	0.88	22	12	14	0.080	2.0	25	11	0.945	24	10.75	1.888
MSC 201	4.00	102	0.88	22	13.5	14	0.080	2.0	25	11	1.063	27	9.41	1.652
MSC 202	2.00	51	0.88	22	8.5	12	0.104	2.6	60	28	0.870	22.1	50.49	8.863
MSC 203	2.50	64	0.88	22	10	12	0.104	2.6	60	28	1.024	26	41.58	7.299
MSC 204	3.00	76	0.88	22	12	12	0.104	2.6	60	28	1.228	31.2	33.66	5.909
MSC 205	3.50	89	0.88	22	14	12	0.104	2.6	60	28	1.433	36.4	28.27	4.963
MSC 206	4.00	102	0.88	22	15.5	12	0.104	2.6	60	28	1.587	40.3	25.24	4.431
MSC 207	2.00	51	0.88	22	9.5	10	0.128	3.2	100	46	1.197	30.4	111.38	19.553
MSC 208	2.50	64	0.88	22	11.5	10	0.128	3.2	100	46	1.449	36.8	89.11	15.643
MSC 209	3.00	76	0.88	22	13.5	10	0.128	3.2	100	46	1.701	43.2	74.25	13.035
MSC 210	3.50	89	0.88	22	15.5	10	0.128	3.2	100	46	1.953	49.6	66.72	11.713
MSC 211	4.00	102	0.88	22	18	10	0.128	3.2	100	46	2.268	57.6	54.00	9.48

Spring No.	Length		Outside Diameter		Total Coils	Wire Dia			Approx. Solid Load		Solid Height		Spring Rate	
	Ins.	mm	Ins.	mm		SWG	Ins.	mm	lb	kg	Ins	mm	lb/in	N/mm
MSC 212	2.50	64	1.00	25	8.5	12	0.104	2.6	55	25	0.870	22.1	32.80	5.758
MSC 213	3.00	76	1.00	25	10	12	0.104	2.6	55	25	1.024	26	27.01	4.741
MSC 214	3.50	89	1.00	25	11.5	12	0.104	2.6	55	25	1.177	29.9	22.96	4.03
MSC 215	4.00	102	1.00	25	13	12	0.104	2.6	55	25	1.331	33.8	19.97	3.505
MSC 216	5.00	128	1.00	25	15.5	12	0.104	2.6	55	25	1.587	40.3	16.40	2.879
MSC 217	2.50	64	1.00	25	9.5	10	0.128	3.2	100	46	1.197	30.4	71.44	12.541
MSC 218	3.00	76	1.00	25	11	10	0.128	3.2	100	46	1.386	35.2	60.16	10.561
MSC 219	3.50	89	1.00	25	12.5	10	0.128	3.2	100	46	1.575	40	51.96	9.121
MSC 220	4.00	102	1.00	25	14	10	0.128	3.2	100	46	1.764	44.8	45.72	8.026
MSC 221	5.00	128	1.00	25	17.5	10	0.128	3.2	100	46	2.205	56	35.72	6.27
MSC 222	2.50	64	1.00	25	10	8	0.16	4.0	170	77	1.575	40	183.62	32.236
MSC 223	3.00	76	1.00	25	12	8	0.16	4.0	170	77	1.890	48	148.65	26.096
MSC 224	3.50	89	1.00	25	14	8	0.16	4.0	170	77	2.205	56	124.87	21.921
MSC 225	4.00	102	1.00	25	15.5	8	0.16	4.0	170	77	2.441	62	110.35	19.372
MSC 226	5.00	128	1.00	25	19.5	8	0.16	4.0	170	77	3.071	78	86.71	15.223

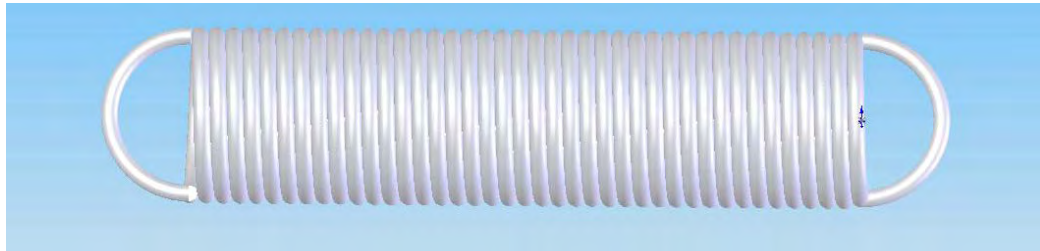

STEEL EXTENSION SPRINGS

FROM STOCK

When ordering it is necessary to specify the full spring reference number.

See also our range of assorted boxes.

All orders subject to a Carriage Charge



Spring No.	Length Inside Loops		Outside Diameter		Wire Dia			Approx. Load In		With Extension Of	
	Ins.	mm	Ins.	mm	SWG	Ins.	mm	lb	kg	Ins.	mm
MSE 289	0.75	19	0.19	4.8	28	0.0148	0.38	0.5	0.23	1.25	32
MSE 290	1.00	25	0.19	4.8	28	0.0148	0.38	0.5	0.23	2.0	51
MSE 291	1.50	38	0.19	4.8	28	0.0148	0.38	0.5	0.23	3.0	76
MSE 292	2.00	51	0.19	4.8	28	0.0148	0.38	0.5	0.23	4.5	115
MSE 293	0.75	19	0.19	4.8	26	0.018	0.45	1	0.46	0.75	19
MSE 294	1.00	25	0.19	4.8	26	0.018	0.45	1	0.46	1.25	32
MSE 295	1.50	38	0.19	4.8	26	0.018	0.45	1	0.46	2.25	56
MSE 296	2.00	51	0.19	4.8	26	0.018	0.45	1	0.46	3.0	76
MSE297	0.75	19	0.19	4.8	24	0.022	0.56	2	0.90	0.5	13
MSE298	1.00	25	0.19	4.8	24	0.022	0.56	2	0.90	0.75	19
MSE299	1.50	38	0.19	4.8	24	0.022	0.56	2	0.90	1.5	38
MSE300	2.00	51	0.19	4.8	24	0.022	0.56	2	0.90	2.0	51
MSE 301	1.5	38	0.25	6.4	23	0.024	0.61	2	0.90	2.0	51
MSE 302	2.0	51	0.25	6.4	23	0.024	0.61	2	0.90	3.5	89
MSE 303	2.5	64	0.25	6.4	23	0.024	0.61	2	0.90	4.5	115
MSE 304	3.0	76	0.25	6.4	23	0.024	0.61	2	0.90	6.0	153
MSE 305	1.5	38	0.25	6.4	21	0.032	0.81	5	2.3	1.0	25
MSE 306	2.0	51	0.25	6.4	21	0.032	0.81	5	2.3	1.5	38
MSE 307	2.5	64	0.25	6.4	21	0.032	0.81	5	2.3	2.0	51
MSE 308	3.0	76	0.25	6.4	21	0.032	0.81	5	2.3	2.5	64
MSE 309	1.5	38	0.25	6.4	19	0.040	1.0	10	4.6	0.5	13
MSE 310	2.0	51	0.25	6.4	19	0.040	1.0	10	4.6	1.0	25
MSE 311	2.5	64	0.25	6.4	19	0.040	1.0	10	4.6	1.25	32
MSE 312	3.0	76	0.25	6.4	19	0.040	1.0	10	4.6	1.5	38

Spring No.	Length Inside Loops		Outside Diameter		Wire Dia			Approx. Load In		With Extension Of	
	Ins.	mm	Ins.	mm	SWG	Ins.	mm	lb	kg	Ins.	mm
MSE 313	2.0	51	0.38	9.5	20	0.036	0.91	5	2.3	2.75	70
MSE 314	2.5	64	0.38	9.5	20	0.036	0.91	5	2.3	4.0	102
MSE 315	3.0	76	0.38	9.5	20	0.036	0.91	5	2.3	5.0	128
MSE 316	4.0	102	0.38	9.5	20	0.036	0.91	5	2.3	7.0	178
MSE 317	2.0	51	0.38	9.5	18	0.048	1.2	15	7.0	1.5	38
MSE 318	2.5	64	0.38	9.5	18	0.048	1.2	15	7.0	2.0	51
MSE 319	3.0	76	0.38	9.5	18	0.048	1.2	15	7.0	2.5	64
MSE 320	4.0	102	0.38	9.5	18	0.048	1.2	15	7.0	3.5	89
MSE321	2.0	51	0.38	9.5	16	0.064	1.6	30	14	0.75	19
MSE322	2.5	64	0.38	9.5	16	0.064	1.6	30	14	1.0	25
MSE323	3.0	76	0.38	9.5	16	0.064	1.6	30	14	1.25	32
MSE324	4.0	102	0.38	9.5	16	0.064	1.6	30	14	1.75	45
MSE325	3.0	76	0.5	13	18	0.048	1.2	10	4.6	4.5	115
MSE326	4.0	102	0.5	13	18	0.048	1.2	10	4.6	6.5	165
MSE327	5.0	128	0.5	13	18	0.048	1.2	10	4.6	8.5	216
MSE328	6.0	153	0.5	13	18	0.048	1.2	10	4.6	10.5	268
MSE329	3.0	76	0.5	13	16	0.064	1.6	20	9.0	2.25	57
MSE330	4.0	102	0.5	13	16	0.064	1.6	20	9.0	3.25	83
MSE331	5.0	128	0.5	13	16	0.064	1.6	20	9.0	4.5	115
MSE332	6.0	153	0.5	13	16	0.064	1.6	20	9.0	5.5	140
MSE 333	3.0	76	0.5	13	14	0.080	2.0	45	20	1.25	32
MSE 334	4.0	102	0.5	13	14	0.080	2.0	45	20	1.75	45
MSE 335	5.0	128	0.5	13	14	0.080	2.0	45	20	2.5	64
MSE 336	6.0	153	0.5	13	14	0.080	2.0	45	20	3.5	76

Spring No.	Length Inside Loops		Outside Diameter		Wire Dia			Approx. Load In		With Extension Of	
	Ins.	mm	Ins.	mm	SWG	Ins.	mm	lb	kg	Ins.	mm
MSE 337	4.0	102	0.75	19	15	0.072	1.8	20	9	5.5	140
MSE 338	5.0	128	0.75	19	15	0.072	1.8	20	9	7.75	197
MSE 339	6.0	153	0.75	19	15	0.072	1.8	20	9	10	255
MSE 340	7.0	178	0.75	19	15	0.072	1.8	20	9	12	306
MSE341	4.0	102	0.75	19	13	0.092	2.3	45	20	3.0	76
MSE342	5.0	128	0.75	19	13	0.092	2.3	45	20	4.0	102
MSE343	6.0	153	0.75	19	13	0.092	2.3	45	20	5.5	140
MSE344	7.0	178	0.75	19	13	0.092	2.3	45	20	6.5	165
MSE 345	5.0	128	0.75	19	11	0.116	2.9	90	41	2.5	64
MSE 346	6.0	154	0.75	19	11	0.116	2.9	90	41	3.0	76
MSE 347	7.0	178	0.75	19	11	0.116	2.9	90	41	3.75	96
MSE 348	8.0	204	0.75	19	11	0.116	2.9	90	41	4.5	115
MSE349	6.0	154	1	25	12	0.104	2.6	50	23	7.25	184
MSE350	7.0	178	1	25	12	0.104	2.6	50	23	9.25	229
MSE351	8.0	204	1	25	12	0.104	2.6	50	23	11.1	280
MSE352	9.0	229	1	25	12	0.104	2.6	50	23	12.6	318
MSE 353	6.0	154	1	25	10	0.128	3.2	90	41	4.5	115
MSE 354	7.0	178	1	25	10	0.128	3.2	90	41	5.5	140
MSE 355	8.0	204	1	25	10	0.128	3.2	90	41	6.5	165
MSE 356	9.0	229	1	25	10	0.128	3.2	90	41	7.5	191

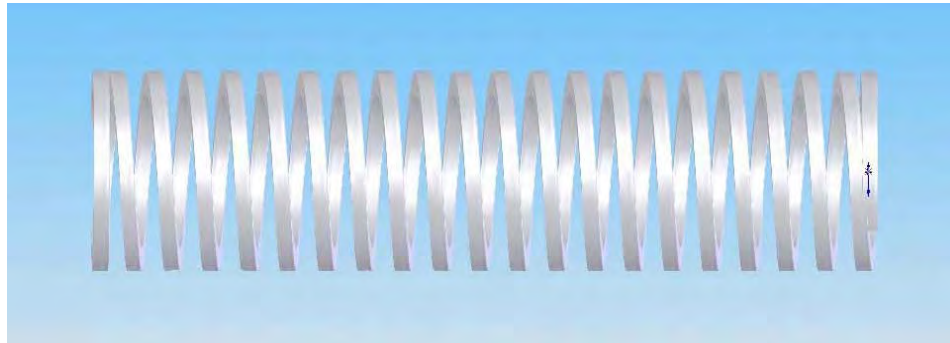

DIE SPRINGS

*FROM STOCK **

AN IMPERIAL RANGE *

Covering over 30 sizes is stocked, details on the following pages.

COLOUR CODED TOOLROOM (METRIC)

Our new colour coded stock metric die springs made from the finest chrome vanadium spring steel.

DESIGNED

To give high load and greatest possible movement consistent with safety.

SHOT PEENING

Has been applied to improve the fatigue life. (Imperial range only).

When ordering it is necessary to specify the full spring reference number.

All orders subject to a Carriage Charge

Spring Number	Length Of Spring		Diameter of Hole in which Spring will work		Diameter of Rod over which Spring will work		Solid Height		Approx. Load to compress solid		Approx. Load to compress .25" 6.4mm	
	Ins.	mm	Ins.	mm	Ins.	mm	Ins.	mm	lb.	kg.	lb.	kg.
MSD 0000	1.0	25	0.75	19	0.38	9.5	0.66	17	140	64	90	41
MSD 000	1.5	38	0.75	19	0.38	9.5	0.90	23	240	109	90	41
MSD 00	2.0	51	0.75	19	0.38	9.5	1.19	31	210	95	60	27
MSD 0	2.5	64	0.75	19	0.38	9.5	1.47	38	202	91	40	18
.....												
MSD 1A	1.5	38	1	25	0.5	13	0.88	22	288	130	85	39
MSD 1	2.0	51	1	25	0.5	13	1.13	29	260	117	60	28
MSD 2	2.5	64	1	25	0.5	13	1.44	37	295	133	50	23
MSD 3	3.0	76	1	25	0.5	13	1.69	43	265	120	40	18
.....												
MSD 4	2.0	51	1.25	32	0.63	16	1.32	34	432	196	186	84
MSD 5	2.5	64	1.25	32	0.63	16	1.59	41	440	199	115	52
MSD 6	3.0	76	1.25	32	0.63	16	1.90	48	450	204	95	43
MSD 7	3.5	89	1.25	32	0.63	16	2.25	57	550	249	80	36
MSD 8	4.0	102	1.25	32	0.63	16	2.50	64	458	207	70	32
MSD 9	4.5	115	1.25	32	0.63	16	2.84	73	442	200	60	28
MSD 10	5.0	128	1.25	32	0.63	16	3.19	81	420	190	55	25
MSD 11	5.5	140	1.25	32	0.63	16	3.41	87	480	217	50	23
MSD 12	6.0	153	1.25	32	0.63	16	3.75	95	450	204	45	20
.....												
MSD 13	2.0	51	1.5	38	0.75	19	1.22	31	630	285	170	78
MSD 14	2.5	64	1.5	38	0.75	19	1.53	39	665	301	140	64
MSD 15	3.0	76	1.5	38	0.75	19	1.84	47	750	340	120	55
MSD 16	3.5	89	1.5	38	0.75	19	2.13	54	690	312	100	46
MSD 17	4.0	102	1.5	38	0.75	19	2.34	60	775	351	90	41
MSD 18	4.5	115	1.5	38	0.75	19	2.78	71	595	269	80	36
MSD 19	5.0	128	1.5	38	0.75	19	3.06	73	587	266	70	32
MSD 20	5.5	140	1.5	38	0.75	19	3.25	83	640	290	60	28
MSD 21	6.0	153	1.5	38	0.75	19	3.50	89	658	298	55	25

Spring Number	Length Of Spring		Diameter of Hole in which Spring will work		Diameter of Rod over which Spring will work		Solid Height		Approx. Load to compress solid		Approx. Load to compress .25" 6.4mm	
	Ins.	mm	Ins.	mm	Ins.	mm	Ins.	mm	lb.	kg.	lb.	kg.
MSD 22	3	76	2	51	1	25	1.75	45	970	439	160	78
MSD 23	4	102	2	51	1	25	2.32	59	965	437	120	55
MSD 24	5	128	2	51	1	25	2.84	73	970	439	90	41
MSD 25	6	153	2	51	1	25	3.38	76	1120	508	90	41
.....												
MSD 01	3.0	76	0.75	19	0.38	9.5	1.66	42	180	82	32	15
MSD 02	3.5	89	0.75	19	0.38	9.5	1.84	47	180	82	28	13
MSD 03	4.0	102	0.75	19	0.38	9.5	2.22	56	180	82	25	11
MSD 04	4.5	115	0.75	19	0.38	9.5	2.44	62	180	82	22	10
MSD 05	5.0	128	0.75	19	0.38	9.5	2.78	71	180	82	20	9
MSD 06	5.5	140	0.75	19	0.38	9.5	2.99	75	180	82	18	8
MSD 07	6.0	153	0.75	19	0.38	9.5	3.09	78	180	82	16	7.3
.....												
MSD B1	1.0	25	1	25	0.5	13	0.63	16	300	136	140	64
MSD B2	3.5	89	1	25	0.5	13	1.94	49	300	136	40	18
MSD B3	4.0	102	1	25	0.5	13	2.16	55	300	136	35	16
MSD B4	4.5	115	1	25	0.5	13	2.31	59	300	136	31	14
MSD B5	5.0	128	1	25	0.5	13	2.59	66	300	136	28	13
MSD B6	5.5	140	1	25	0.5	13	2.84	72	300	136	25	11
MSD B7	6.0	153	1	25	0.5	13	3.06	78	300	136	22	10
MSD B8	8.0	204	1	25	0.5	13	4.19	106	300	136	16	7.3
.....												
MSD C1	1.0	25	1.13	28.6	0.56	14.5	0.72	18	426	194	380	172
MSD C2	1.5	38	1.13	28.6	0.56	14.5	1.03	26	540	245	270	127
MSD C3	2.0	51	1.13	28.6	0.56	14.5	1.25	32	560	246	186	84

Spring Number	Length Of Spring		Diameter of Hole in which Spring will work		Diameter of Rod over which Spring will work		Solid Height		Approx. Load to compress solid		Approx. Load to compress .25" 6.4mm	
	Ins.	mm	Ins.	mm	Ins.	mm	Ins.	mm	lb.	kg.	lb.	kg.
MSD C4	2.5	51	1.13	28.6	0.56	14.5	6.50	38	575	261	150	68
MSD C5	3.0	76	1.13	28.6	0.56	14.5	1.80	46	575	261	120	55
MSD C6	3.5	89	1.13	28.6	0.56	14.5	2.03	52	575	261	95	43
MSD C7	4.0	102	1.13	28.6	0.56	14.5	2.34	59	575	261	82	37
MSD C8	4.5	115	1.13	28.6	0.56	14.5	2.63	67	575	261	78	35
MSD C9	5.0	128	1.13	28.6	0.56	14.5	3.00	76	575	261	66	30
MSD C10	5.5	140	1.13	28.6	0.56	14.5	3.31	84	575	261	62	28
MSD C11	6.0	153	1.13	28.6	0.56	14.5	3.50	89	575	261	57	26
.....												
MSD D1	1.0	25	1.25	32	0.63	16	0.69	18	409	182	320	145
MSD D2	1.5	38	1.25	32	0.63	16	1.00	25	409	182	210	95
.....												
MSD E1	1.0	25	1.5	38	0.75	19	0.78	20	600	272	450	204
MSD E2	1.5	38	1.5	38	0.75	19	1.06	27	600	272	300	136
.....												
MSD G1	2.0	51	2	51	1	25	1.19	30	800	364	323	147
MSD G2	8.0	203	2	51	1	25	4.63	118	800	364	58	26
MSD G3	9.0	229	2	51	1	25	5.00	127	800	364	50	23
1 3/4 OD Sizes available on application												

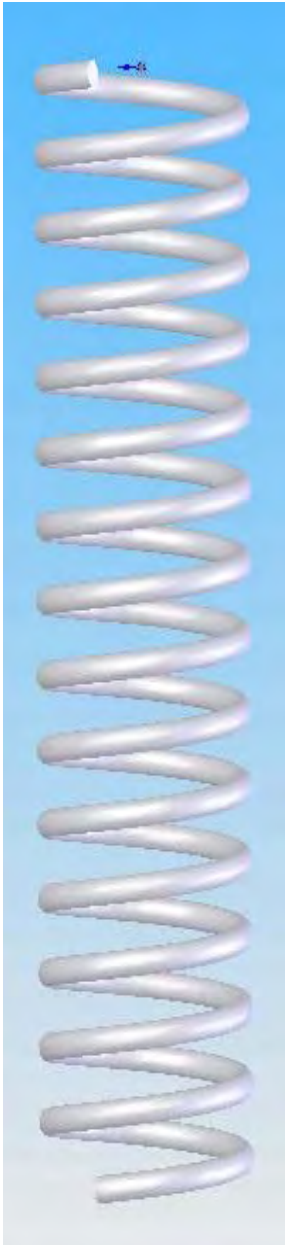

(305mm) Open Coiled Lengths

Spring Number	Outside Diameter		Coils per Inch	Wire Diameter		
	Ins.	mm		SWG	Ins.	mm
MSL 401	0.19	4.80	15	26	0.018	0.45
MSL 402	0.19	4.80	16	24	0.022	0.56
MSL 403	0.19	4.80	17	22	0.028	0.71
MSL 404	0.25	6.40	11	23	0.024	0.61
MSL 405	0.25	6.40	13	21	0.032	0.81
MSL 406	0.25	6.40	14	19	0.040	1.00
MSL 407	0.31	8.00	9	22	0.028	0.71
MSL 408	0.31	8.00	10	20	0.036	0.91
MSL 409	0.31	8.00	12	18	0.048	1.20
MSL 410	0.38	9.50	7	20	0.036	0.91
MSL 411	0.38	9.50	9	18	0.048	1.20
MSL 412	0.38	9.50	9	16	0.064	1.60
MSL 413	0.44	11.0	6	19	0.040	1.00
MSL 414	0.44	11.0	7	17	0.056	1.40
MSL 415	0.44	11.0	8	15	0.072	1.80
MSL 416	0.50	13.0	6	18	0.048	1.20
MSL 417	0.50	13.0	6	16	0.064	1.60
MSL 418	0.50	13.0	7	14	0.080	2.00
MSL 419	0.75	19.0	4	15	0.072	1.80
MSL 420	0.75	19.0	4	13	0.092	2.30
MSL 421	0.75	19.0	5	11	0.116	2.90

Suitable for cutting into shorter lengths.
 Box AC Containg 1 of each type MSL 401-421 Available



12" (305mm) Close Coiled Lengths

Spring Number	Outside Diameter		Wire Diameter		
	Ins.	mm	SWG	Ins.	mm
MSL 501	0.19	4.80	26	0.018	0.45
MSL 502	0.19	4.80	24	0.022	0.56
MSL 503	0.19	4.80	22	0.028	0.71
MSL 504	0.25	6.40	23	0.024	0.61
MSL 505	0.25	6.40	21	0.032	0.81
MSL 506	0.25	6.40	19	0.040	1.00
MSL 507	0.38	9.50	20	0.036	0.91
MSL 508	0.38	9.50	18	0.048	1.20
MSL 509	0.38	9.50	16	0.064	1.60
MSL 510	0.50	13.00	18	0.048	1.20
MSL 511	0.50	13.00	16	0.064	1.60
MSL 512	0.50	13.00	14	0.080	2.00
MSL 513	0.75	19.00	15	0.072	1.80
MSL 514	0.75	19.00	13	0.092	2.30
MSL 515	0.75	19.00	11	0.116	2.90

Suitable for cutting into shorter lengths.
 Box AE Containg 1 of each type MSL 501-515 Available

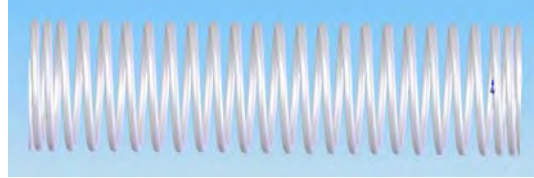

BOXED ASSORTED STEEL COMPRESSION SPRINGS

FROM STOCK

BOX A	Containing 100 Springs 4 off each type	MSC89 – MSC113
BOX B	Containing 100 Springs 4 off each type	MSC112 – MSC136
BOX C	Containing 100 Springs 4 off each type	MSC135 – MSC159
BOX D	Containing 50 Springs 2 off each type	MSC158 – MSC182
BOX E	Containing 50 Springs 2 off each type	MSC181 – MSC205
BOX F	Containing 50 Springs 2 off each type	MSC202 – MSC226

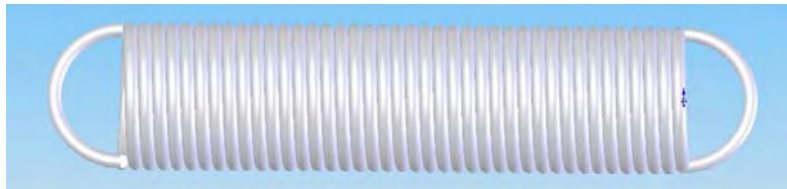

BOXED ASSORTED STEEL EXTENSION SPRINGS

FROM STOCK

BOX P	Containing 100 Springs 4 off each type	MSE289 – MSE313
BOX Q	Containing 50 Springs 2 off each type	MSE310 – MSE334
BOX R	Containing 50 Springs 2 off each type	MSE332 – MSE356

When ordering it is necessary to specify the full spring reference number.

All orders subject to a Carriage Charge



FROM CAD DESIGN TO MANUFACTURE

We can off you the total package.

With the latest in 2D & 3D Computer aided design packages, we are able to import and export files of virtually all formats, including, IGES, DWG, STP, DXF and many more, we can view your files or our expert designers can draw your parts for you.

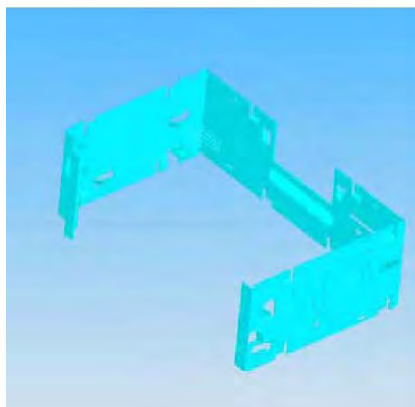
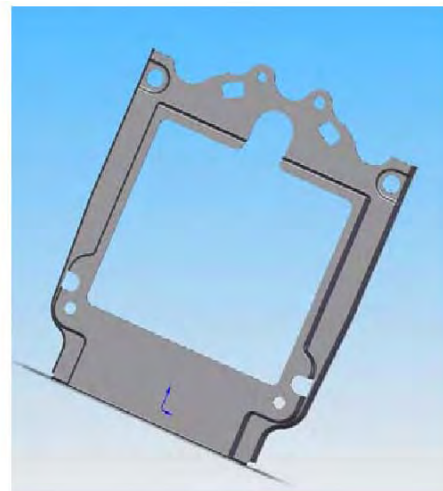
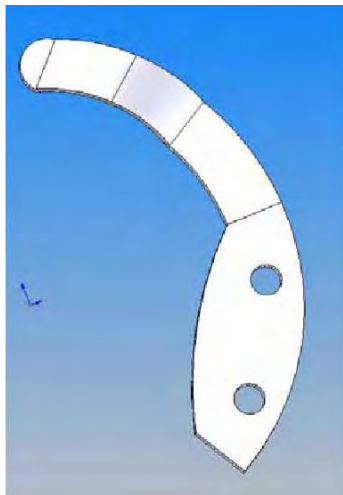

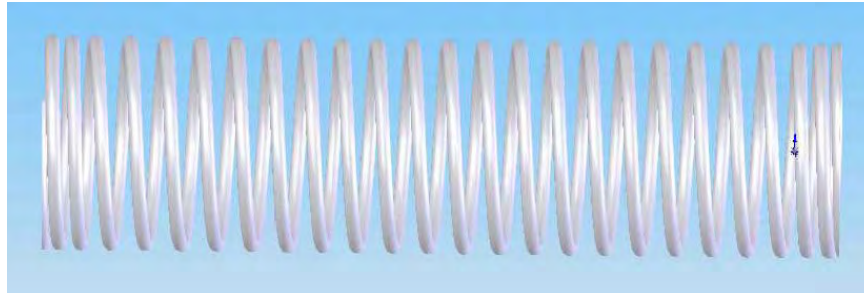

METRIC STEEL COMPRESSION SPRINGS

FROM STOCK

When ordering it is necessary to specify the full spring reference number.

Please note wire sizes under 0.5mm are un-ground.

All orders subject to a Carriage Charge

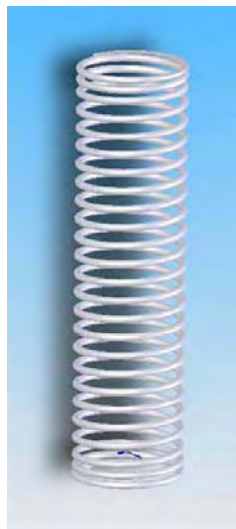

Part no.	Outside Diameter	Inside Diameter	Wire Diameter	Free Length	Minimum Working Length	Total Coils	Spring Rate Kg/mm
MMC 1	3.00	2.37	0.315	10	3.86	10 ³ / ₄	0.0581
MMC 2				15	5.28	15 ¹ / ₄	0.0384
MMC 3				20	6.78	20	0.0282
MMC 4				25	8.19	24 ¹ / ₂	0.0226
MMC 5				30	9.61	29	0.0188
MMC 6	3.00	2.33	0.335	10	4.11	10 ³ / ₄	0.0760
MMC 7				15	5.78	15 ³ / ₄	0.0483
MMC 8				20	7.46	20 ³ / ₄	0.0354
MMC 9				25	9.13	25 ³ / ₄	0.0280
MMC 10				30	10.73	30 ¹ / ₂	0.0233
MMC 11	3.00	2.29	0.355	10	4.44	11	0.0953
MMC 12				15	6.31	16 ¹ / ₄	0.0602
MMC 13				20	8.17	21 ¹ / ₂	0.0440
MMC 14				25	9.95	26 ¹ / ₂	0.0350
MMC 15				30	11.81	31 ³ / ₄	0.0288
MMC 16	3.00	2.25	0.375	10	4.88	11 ¹ / ₂	0.1150
MMC 17				15	6.94	17	0.0728
MMC 18				20	9.00	22 ¹ / ₂	0.0533
MMC 19				25	11.00	27 ³ / ₄	0.0424
MMC 20				30	13.04	33 ¹ / ₄	0.0349
MMC 21	3.50	2.75	0.375	10	4.09	9 ¹ / ₄	0.0893
MMC 22				15	5.63	13 ¹ / ₂	0.0563
MMC 23				20	7.22	17 ³ / ₄	0.0411
MMC 24				25	8.82	22	0.0324
MMC 25				30	10.41	26 ¹ / ₄	0.0267
MMC 26				35	12.00	30 ¹ / ₂	0.0227
MMC 27				40	13.60	34 ³ / ₄	0.0197
MMC 28				50	16.79	43 ¹ / ₄	0.0157
MMC 29	3.50	2.70	0.400	10	4.45	9 ¹ / ₂	0.1145
MMC 30				15	6.20	14	0.0716
MMC 31				20	7.98	18 ¹ / ₄	0.0528
MMC 32				25	9.70	22 ³ / ₄	0.0414
MMC 33				30	11.50	27	0.0343
MMC 34				35	13.20	31 ¹ / ₂	0.0291
MMC 35				40	15.00	36	0.0252
MMC 36				50	18.50	44 ³ / ₄	0.0201
MMC 37	3.50	2.65	0.425	10	4.79	9 ³ / ₄	0.1447
MMC 38				15	6.80	14 ¹ / ₂	0.0897
MMC 39				20	8.72	19	0.0660
MMC 40				25	10.63	23 ¹ / ₂	0.0521
MMC 41				30	12.54	28	0.0431
MMC 42				35	14.46	32 ¹ / ₂	0.0367
MMC 43				40	16.42	37	0.0320
MMC 44				50	20.30	46 ¹ / ₄	0.0253

Part no.	Outside Diameter	Inside Diameter	Wire Diameter	Free Length	Minimum Working Length	Total Coils	Spring Rate Kg/mm
MMC 45	3.50	2.60	0.450	10	5.18	10	0.1806
MMC 46				15	7.32	14 ³ / ₄	0.1133
MMC 47				20	9.45	19 ¹ / ₂	0.0825
MMC 48				25	11.58	24	0.0656
MMC 49				30	13.68	28 ³ / ₄	0.0540
MMC 50				35	15.78	33 ¹ / ₂	0.0458
MMC 51				40	17.89	38 ¹ / ₄	0.0398
MMC 52				50	22.17	17 ³ / ₄	0.0315
MMC 53	4.00	3.20	0.400	10	3.90	8 ¹ / ₄	0.0877
MMC 54				15	5.30	11 ³ / ₄	0.0562
MMC 55				20	6.70	15 ¹ / ₄	0.0414
MMC 56				25	8.10	18 ³ / ₄	0.0327
MMC 57				30	9.50	22 ¹ / ₄	0.0270
MMC 58				35	10.90	25 ³ / ₄	0.0231
MMC 59				40	12.30	29 ¹ / ₄	0.0201
MMC 60				50	15.20	36 ¹ / ₂	0.0159
MMC 61	4.00	3.15	0.425	10	4.25	8 ¹ / ₂	0.1098
MMC 62				15	5.85	12 ¹ / ₄	0.0696
MMC 63				20	7.44	16	0.0510
MMC 64				25	9.04	19 ³ / ₄	0.0402
MMC 65				30	10.63	23 ¹ / ₂	0.0332
MMC 66				35	12.12	27	0.0285
MMC 67				40	13.60	30 ¹ / ₂	0.0250
MMC 68				50	16.69	37 ³ / ₄	0.0199
MMC 69	4.00	3.10	0.450	10	4.50	8 ¹ / ₂	0.1410
MMC 70				15	6.30	12 ¹ / ₂	0.0872
MMC 71				20	8.10	16 ¹ / ₂	0.0632
MMC 72				25	9.79	20 ¹ / ₄	0.0502
MMC 73				30	11.50	24	0.0416
MMC 74				35	13.17	27 ³ / ₄	0.0355
MMC 75				40	14.97	31 ³ / ₄	0.0308
MMC 76				50	18.34	39 ¹ / ₄	0.0246
MMC 77	4.00	3.00	0.500	10	4.88	9 ¹ / ₄	0.2010
MMC 78				15	6.89	13 ¹ / ₄	0.1295
MMC 79				20	9.00	17 ¹ / ₂	0.0940
MMC 80				25	11.00	21 ¹ / ₂	0.0747
MMC 81				30	13.07	25 ¹ / ₂	0.0620
MMC 82				35	15.13	29 ³ / ₄	0.0525
MMC 83				40	17.13	33 ³ / ₄	0.0459
MMC 84				50	21.25	42	0.0364
MMC 85	4.50	3.60	0.450	10	4.05	7 ¹ / ₂	0.1122
MMC 86				15	5.52	10 ³ / ₄	0.0705
MMC 87				20	6.98	14	0.0514
MMC 88				25	8.45	17 ¹ / ₄	0.0404
MMC 89				30	9.92	20 ¹ / ₂	0.0333
MMC 90				35	11.37	23 ³ / ₄	0.0283
MMC 91				40	12.85	27	0.0246
MMC 92				50	15.76	33 ¹ / ₂	0.0195

Part no.	Outside Diameter	Inside Diameter	Wire Diameter	Free Length	Minimum Working Length	Total Coils	Spring Rate Kg/mm
MMC 93	4.50	3.50	0.500	10	4.25	8	0.1627
MMC 94				15	6.02	11½	0.1027
MMC 95				20	7.68	14¾	0.0765
MMC 96				25	9.38	18¼	0.0600
MMC 97				30	11.13	21¾	0.0494
MMC 98				35	12.88	25¼	0.0492
MMC 99				40	14.50	28½	0.0368
MMC 100				50	17.90	35¼	0.0293
MMC 101	4.50	3.38	0.56	10	4.95	8¼	0.2572
MMC 102				15	7.00	12	0.1607
MMC 103				20	9.10	15¾	0.1169
MMC 104				25	11.07	19¼	0.0932
MMC 105				30	13.16	23	0.0765
MMC 106				35	15.26	26¾	0.0649
MMC 107				40	17.22	30¼	0.0569
MMC 108				50	21.30	37½	0.0452
MMC 109	4.50	3.30	0.60	10	5.40	8½	0.3361
MMC 110				15	7.65	12¼	0.2131
MMC 111				20	9.90	16	0.1560
MMC 112				25	12.15	19¾	0.1230
MMC 113				30	14.40	23½	0.1016
MMC 114				35	16.65	27¼	0.0865
MMC 115				40	18.90	31	0.0753
MMC 116				50	23.41	38½	0.0598
MMC 117	5.00	4.00	0.50	10	3.79	7	0.1371
MMC 118				15	5.25	10	0.0857
MMC 119				20	6.67	12¾	0.0638
MMC 120				25	8.13	15¾	0.0498
MMC 121				30	9.54	18½	0.0415
MMC 122				35	11.00	21½	0.0351
MMC 123				40	12.40	24¼	0.0308
MMC 124				50	15.25	30	0.0244
MMC 125	5.00	3.88	0.56	10	4.48	7½	0.2042
MMC 126				15	6.22	10½	0.1321
MMC 127				20	7.98	13¾	0.0956
MMC 128				25	9.80	17	0.0749
MMC 129				30	11.48	20	0.0624
MMC 130				35	13.16	23	0.0535
MMC 131				40	14.98	26¼	0.0463
MMC 132				50	18.48	32½	0.0368
MMC 133	5.00	3.74	0.63	10	5.20	7¾	0.3283
MMC 134				15	7.25	11	0.2097
MMC 135				20	9.45	14½	0.1510
MMC 136				25	11.50	17¾	0.1198
MMC 137				30	13.55	21	0.0993
MMC 138				35	15.60	24¼	0.0848
MMC 139				40	17.80	27¾	0.0733
MMC 140				50	22.05	24½	0.0580

Part no.	Outside Diameter	Inside Diameter	Wire Diameter	Free Length	Minimum Working Length	Total Coils	Spring Rate Kg/mm
MMC 141	5.00	3.66	0.67	10	5.53	7¾	0.4317
MMC 142				15	7.88	11¼	0.2683
MMC 143				20	10.05	14½	0.1985
MMC 144				25	12.40	18	0.1551
MMC 145				30	14.74	21½	0.1273
MMC 146				35	16.92	24¾	0.1091
MMC 147				40	19.27	28¼	0.0945
MMC 148				50	23.79	35	0.0752
MMC 149	5.50	4.38	0.56	15	5.52	9¼	0.1125
MMC 150				20	7.00	12	0.0815
MMC 151				25	8.42	14½	0.0652
MMC 152				30	10.02	17¼	0.0534
MMC 153				35	11.48	20	0.0453
MMC 154				40	12.88	22½	0.0397
MMC 155				50	15.82	27¾	0.0316
MMC 156				60	18.90	33¼	0.0261
MMC 157	5.50	4.25	0.63	15	6.48	9¾	0.1759
MMC 158				20	8.35	12¾	0.1268
MMC 159				25	10.08	15½	0.1010
MMC 160				30	11.97	18½	0.0826
MMC 161				35	13.71	21¼	0.0708
MMC 162				40	15.60	24¼	0.0612
MMC 163				50	19.23	30	0.0487
MMC 164				60	22.68	35½	0.0407
MMC 165	5.50	4.08	0.71	15	7.64	10¼	0.2802
MMC 166				20	9.77	13¼	0.2055
MMC 167				25	11.92	16¼	0.1622
MMC 168				30	14.20	19½	0.1321
MMC 169				35	16.33	22½	0.1128
MMC 170				40	18.46	25½	0.0983
MMC 171				50	22.90	31¾	0.0777
MMC 172				60	27.16	37¾	0.0646
MMC 173	5.50	4.00	0.75	15	8.07	10¼	0.3578
MMC 174				20	10.50	13½	0.2567
MMC 175				25	12.78	16½	0.2036
MMC 176				30	15.19	19¾	0.1663
MMC 177				35	17.51	22¾	0.1422
MMC 178				40	19.88	26	0.1230
MMC 179				50	24.57	32¼	0.0976
MMC 180				60	29.25	38½	0.0808
MMC 181	6.00	4.74	0.63	15	5.83	8¾	0.1507
MMC 182				20	7.40	11¼	0.1099
MMC 183				25	8.89	13¾	0.0865
MMC 184				30	10.56	16¼	0.0713
MMC 185				35	12.13	18¾	0.0607
MMC 186				40	13.72	21¼	0.0528
MMC 187				50	16.87	26¼	0.0419
MMC 188				60	20.02	31¼	0.0347

Part no.	Outside Diameter	Inside Diameter	Wire Diameter	Free Length	Minimum Working Length	Total Coils	Spring Rate Kg/mm
MMC 189	6.00	4.58	0.71	15	8.07	9¼	0.2367
MMC 190				20	8.88	12	0.1716
MMC 191				25	10.83	14¾	0.1346
MMC 192				30	12.65	17¼	0.1125
MMC 193				35	14.56	20	0.0953
MMC 194				40	16.51	22¾	0.0827
MMC 195				50	20.42	28¼	0.0653
MMC 196				60	24.32	33¾	0.0540
MMC 197	6.00	4.40	0.80	15	8.00	9½	0.3884
MMC 198				20	10.40	12½	0.2774
MMC 199				25	12.60	15¼	0.2198
MMC 200				30	15.00	18¼	0.1792
MMC 201				35	17.20	21	0.1533
MMC 202				40	19.50	23¾	0.1339
MMC 203				50	24.05	29½	0.1059
MMC 204				60	28.62	35¼	0.0876
MMC 205	6.00	4.30	0.85	15	8.72	9¾	0.4931
MMC 206				20	11.27	12¾	0.3554
MMC 207				25	13.60	15½	0.2830
MMC 208				30	16.15	18½	0.2316
MMC 209				35	18.70	21½	0.1959
MMC 210				40	21.07	24¼	0.1717
MMC 211				50	26.14	30¼	0.1352
MMC 212				60	31.07	36	0.1123
MMC 213	7.00	5.58	0.71	15	5.86	7¾	0.1775
MMC 214				20	7.28	9¾	0.1317
MMC 215				25	8.88	12	0.1021
MMC 216				30	10.30	14	0.0850
MMC 217				35	11.72	16	0.0729
MMC 218				40	13.33	18¼	0.0628
MMC 219				50	16.65	22½	0.0498
MMC 220				60	19.35	26¾	0.0412
MMC 221	7.00	5.40	0.80	15	6.80	8	0.2864
MMC 222				20	8.60	10¼	0.2083
MMC 223				25	10.48	12½	0.1636
MMC 224				30	12.35	14¾	0.1347
MMC 225				35	14.15	17	0.1145
MMC 226				40	16.00	19½	0.0982
MMC 227				50	19.60	24	0.0781
MMC 228				60	23.35	28½	0.0648
MMC 229	7.00	5.20	0.90	15	7.88	8¼	0.4624
MMC 230				20	10.13	10¾	0.3303
MMC 231				25	12.38	13¼	0.2569
MMC 232				30	14.63	15¾	0.2102
MMC 233				35	16.88	18¼	0.1778
MMC 234				40	18.90	20½	0.1562
MMC 235				50	23.40	25½	0.1229
MMC 236				60	27.90	30½	0.1014

Part no.	Outside Diameter	Inside Diameter	Wire Diameter	Free Length	Minimum Working Length	Total Coils	Spring Rate Kg/mm
MMC 237	7.00	5.10	0.95	15	8.55	8½	0.5658
MMC 238				20	10.93	11	0.4087
MMC 239				25	13.30	13½	0.3198
MMC 240				30	15.68	16	0.2627
MMC 241				35	18.05	18½	0.2229
MMC 242				40	20.43	21	0.1935
MMC 243				50	25.18	26	0.1532
MMC 244				60	29.93	31	0.1268
MMC 245	8.00	6.40	0.80	15	6.00	7	0.2194
MMC 246				20	7.40	8¾	0.1625
MMC 247				25	8.80	10½	0.1291
MMC 248				30	10.40	12½	0.1045
MMC 249				40	13.25	16	0.0783
MMC 250				50	16.20	19¾	0.0618
MMC 251				60	19.20	23½	0.0510
MMC 252				70	22.20	27	0.0438
MMC 253	8.00	6.20	0.90	15	7.00	7¼	0.3491
MMC 254				20	8.78	9¼	0.2528
MMC 255				25	10.58	11¼	0.1981
MMC 256				30	12.38	13¼	0.1629
MMC 257				40	15.98	17¼	0.1202
MMC 258				50	19.58	21¼	0.0952
MMC 259				60	23.18	25¼	0.0788
MMC 260				70	26.78	29¼	0.0672
MMC 261	8.00	6.00	1.00	15	8.00	7½	0.5300
MMC 262				20	10.00	9½	0.3887
MMC 263				25	12.75	11¾	0.2990
MMC 264				30	14.50	14	0.2429
MMC 265				40	18.75	18¼	0.1794
MMC 266				50	23.00	22½	0.1422
MMC 267				60	27.25	26¾	0.1177
MMC 268				70	31.50	31	0.1005
MMC 269	8.00	5.76	1.12	15	8.96	7½	0.8785
MMC 270				20	11.48	9¾	0.6234
MMC 271				25	14.00	12	0.4831
MMC 272				30	16.52	14¼	0.3944
MMC 273				40	21.56	18¾	0.2884
MMC 274				50	26.60	23¼	0.2273
MMC 275				60	31.64	27¾	0.1876
MMC 276				70	36.68	32¼	0.1597
MMC 277	9.00	7.20	0.90	20	7.65	8	0.2057
MMC 278				25	9.23	9¾	0.1592
MMC 279				30	10.62	11¼	0.1334
MMC 280				40	13.73	14¾	0.0968
MMC 281				50	16.65	18	0.0771
MMC 282				60	19.80	21½	0.0633
MMC 283				70	22.73	24¾	0.0542
MMC 284				80	25.65	28	0.0474

Part no.	Outside Diameter	Inside Diameter	Wire Diameter	Free Length	Minimum Working Length	Total Coils	Spring Rate Kg/mm
MMC 285	9.00	7.00	1.00	20	9.00	8½	0.3004
MMC 286				25	10.75	10¼	0.2367
MMC 287				30	12.50	12	0.1953
MMC 288				40	16.00	15½	0.1446
MMC 289				50	19.75	19¼	0.1132
MMC 290				60	23.75	22¾	0.0941
MMC 291				70	26.75	26¼	0.0805
MMC 292				80	30.32	29¾	0.0703
MMC 293				9.00	6.76	1.12	20
MMC 294	25	12.32	10½				0.3783
MMC 295	30	14.56	12½				0.3062
MMC 296	40	18.86	16¼				0.2256
MMC 297	50	23.24	20¼				0.1762
MMC 298	60	27.44	24				0.1461
MMC 299	70	31.64	27¾				0.1248
MMC 300	80	35.84	31½				0.1090
MMC 301	9.00	6.50	1.25				20
MMC 302				25	14.07	10¾	0.5994
MMC 303				30	16.57	12¾	0.4879
MMC 304				40	21.57	16¾	0.3555
MMC 305				50	26.57	20¾	0.2797
MMC 306				60	31.57	24¾	0.2305
MMC 307				70	36.57	28¾	0.196
MMC 308				80	41.57	32¾	0.1705
MMC 309	10.00	8.00	1.00	20	8.00	7½	0.2494
MMC 310				25	9.50	9	0.1959
MMC 311				30	11.00	10½	0.1613
MMC 312				40	14.00	13½	0.1192
MMC 313				50	17.00	16½	0.0946
MMC 314				60	20.00	19½	0.0783
MMC 315				70	23.00	22½	0.0669
MMC 316				80	26.00	25½	0.0583
MMC 317	10.00	7.76	1.12	20	9.24	7¾	0.3908
MMC 318				25	10.98	9¼	0.3099
MMC 319				30	12.88	11	0.2496
MMC 320				40	16.52	14¼	0.1834
MMC 321				50	20.16	17½	0.1449
MMC 322				60	23.80	20¾	0.1198
MMC 323				70	27.44	24	0.1021
MMC 324				80	31.10	27¼	0.0889
MMC 325	10.00	7.50	1.25	20	10.63	8	0.6073
MMC 326				25	12.82	9¾	0.4702
MMC 327				30	15.00	11½	0.3836
MMC 328				40	19.07	14¾	0.2858
MMC 329				50	23.44	18¼	0.2242
MMC 330				60	27.82	21	0.1845
MMC 331				70	32.19	25¼	0.1567
MMC 332				80	36.25	28½	0.1375

Part no.	Outside Diameter	Inside Diameter	Wire Diameter	Free Length	Minimum Working Length	Total Coils	Spring Rate Kg/mm
MMC 333	10.00	7.20	1.40	20	11.90	8	1.0066
MMC 334				25	14.39	9¾	0.7793
MMC 335				30	17.10	11¾	0.6194
MMC 336				40	22.05	15¼	0.4558
MMC 337				50	27.30	19	0.3552
MMC 338				60	32.20	22½	0.2946
MMC 339				70	37.45	26¼	0.2490
MMC 340				80	42.35	29¾	0.2176
MMC 341	11.00	8.76	1.12	25	9.80	8¼	0.2610
MMC 342				30	11.48	9¾	0.2105
MMC 343				40	14.56	12½	0.1553
MMC 344				50	17.64	15¼	0.1231
MMC 345				60	20.92	18	0.1019
MMC 346				70	24.08	21	0.0858
MMC 347				80	27.16	23¾	0.0750
MMC 348				100	33.32	29¼	0.0598
MMC 349	11.00	8.50	1.25	25	11.57	8¾	0.3902
MMC 350				30	13.44	10¼	0.3192
MMC 351				40	17.19	13¼	0.2341
MMC 352				50	20.94	16¼	0.1848
MMC 353				60	24.69	19¼	0.1527
MMC 354				70	28.44	22¼	0.1300
MMC 355				80	32.19	25¼	0.1132
MMC 356				100	39.69	31¼	0.0900
MMC 357	11.00	8.20	1.40	25	13.30	9	0.6203
MMC 358				30	15.40	10½	0.5108
MMC 359				40	19.95	13¾	0.3695
MMC 360				50	24.50	17	0.2894
MMC 361				60	28.70	20	0.2412
MMC 362				70	33.24	23¼	0.2043
MMC 363				80	37.80	26½	0.1772
MMC 364				100	46.55	32¾	0.1412
MMC 365	11.00	8.00	1.50	25	14.25	9	0.8435
MMC 366				30	16.88	10¾	0.6748
MMC 367				40	21.75	14	0.4920
MMC 368				50	26.63	17¼	0.3872
MMC 369				60	31.50	20½	0.3192
MMC 370				70	36.38	23¾	0.2714
MMC 371				80	41.25	27	0.2362
MMC 372				100	51.00	33½	0.1874
MMC 373	12.00	9.50	1.25	25	10.32	7¼	0.3417
MMC 374				30	12.19	9¼	0.2710
MMC 375				40	15.32	11¾	0.2015
MMC 376				50	18.44	14¼	0.1604
MMC 377				60	21.88	17	0.1310
MMC 378				70	25.00	19½	0.1122
MMC 379				80	28.44	22¼	0.0970
MMC 380				100	35.00	27½	0.0770

Part no.	Outside Diameter	Inside Diameter	Wire Diameter	Free Length	Minimum Working Length	Total Coils	Spring Rate Kg/mm
MMC 381	12.00	9.20	1.40	25	12.14	8	0.5375
MMC 382				30	14.00	9½	0.4300
MMC 383				40	18.05	12¼	0.3146
MMC 384				50	22.05	15¼	0.2434
MMC 385				60	25.90	18	0.2015
MMC 386				70	29.82	20¾	0.1720
MMC 387				80	33.90	23½	0.1500
MMC 388				100	40.60	29¼	0.1183
MMC 389	12.00	8.80	1.60	25	14.12	8¼	0.9321
MMC 390				30	16.50	9¾	0.7517
MMC 391				40	21.20	12¾	0.5419
MMC 392				50	26.05	15¾	0.4237
MMC 393				60	30.83	18¾	0.3478
MMC 394				70	35.60	21¾	0.2949
MMC 395				80	40.40	24¾	0.2560
MMC 396				100	50.00	30¾	0.2026
MMC 397	12.00	8.60	1.70	25	15.30	8½	1.1758
MMC 398				30	17.85	10	0.9553
MMC 399				40	22.95	13	0.6948
MMC 400				50	28.05	16	0.5459
MMC 401				60	33.15	19	0.4495
MMC 402				70	38.68	22¼	0.3774
MMC 403				80	43.78	25¼	0.3287
MMC 404				100	53.98	31¼	0.2612
MMC 405	13.00	10.36	1.32	30	11.88	8½	0.2931
MMC 406				40	14.85	10¾	0.2177
MMC 407				50	18.15	13¼	0.1693
MMC 408				60	21.12	15½	0.1411
MMC 409				70	24.42	18	0.119
MMC 410				80	27.39	20¼	0.1044
MMC 411				10	33.66	25	0.0828
MMC 412				120	39.93	29¾	0.0686
MMC 413	13.00	10.20	1.40	30	19.95	8¾	0.3646
MMC 414				40	16.45	11¼	0.266
MMC 415				50	19.95	13¾	0.2094
MMC 416				60	23.10	16	0.1757
MMC 417				70	26.60	18½	0.1491
MMC 418				80	30.10	21	0.1295
MMC 419				10	37.10	26	0.1025
MMC 420				120	44.10	31	0.0848
MMC 421	13.00	9.80	1.60	30	15.20	9	0.6319
MMC 422				40	19.60	11¾	0.4536
MMC 423				50	24.00	14½	0.3538
MMC 424				60	28.06	17	0.2948
MMC 425				70	32.40	19¾	0.2492
MMC 426				80	36.80	22½	0.2157
MMC 427				10	45.60	28	0.1701
MMC 428				120	54.00	33¼	0.1415

Part no.	Outside Diameter	Inside Diameter	Wire Diameter	Free Length	Minimum Working Length	Total Coils	Spring Rate Kg/mm
MMC 429	13.00	9.40	1.80	30	17.55	9¼	1.0306
MMC 430				40	22.66	12	0.7471
MMC 431				50	27.90	15	0.5747
MMC 432				60	32.85	17¾	0.4744
MMC 433				70	37.92	20½	0.4038
MMC 434				80	43.20	23½	0.3475
MMC 435				10	53.55	29¼	0.2742
MMC 436				120	63.45	34¾	0.2281
MMC 437	14.00	11.20	1.40	30	11.90	8	0.3200
MMC 438				40	14.82	10	0.2400
MMC 439				50	17.85	12¼	0.1873
MMC 440				60	21.00	14½	0.1536
MMC 441				70	24.15	16¾	0.1302
MMC 442				80	27.30	19	0.1129
MMC 443				10	33.25	23¼	0.0903
MMC 444				120	39.80	27½	0.00753
MMC 445	14.00	10.80	1.60	30	14.00	8¼	0.5499
MMC 446				40	18.00	10¾	0.3928
MMC 447				50	21.81	13	0.3124
MMC 448				60	25.60	15½	0.2546
MMC 449				70	29.60	18	0.2148
MMC 450				80	33.23	20¼	0.1883
MMC 451				10	41.20	25¼	0.1478
MMC 452				120	48.80	30	0.1227
MMC 453	14.00	10.40	1.80	30	16.40	8½	0.8893
MMC 454				40	20.70	11¼	0.6249
MMC 455				50	25.65	13¾	0.4920
MMC 456				60	30.19	16¼	0.4056
MMC 457				70	35.10	19	0.3400
MMC 458				80	39.60	21½	0.2964
MMC 459				10	48.72	26½	0.2359
MMC 460				120	58.05	31¾	3.1943
MMC 461	14.00	10.00	2.00	30	18.50	8¾	1.3717
MMC 462				40	24.00	11½	0.9746
MMC 463				50	29.14	14	0.7716
MMC 464				60	34.50	16¾	0.6277
MMC 465				70	40.00	19½	0.5291
MMC 466				80	45.50	22¼	0.4572
MMC 467				10	56.00	27½	0.3631
MMC 468				120	66.60	32¾	0.3011
MMC 469	15.00	12.00	1.50	30	12.00	7½	0.3741
MMC 470				40	15.00	9½	0.2743
MMC 471				50	18.20	11½	0.2165
MMC 472				60	21.38	13¾	0.1751
MMC 473				70	24.38	15¾	0.1496
MMC 474				80	27.38	17¾	0.1306
MMC 475				10	33.75	22	0.1028
MMC 476				120	39.75	26	0.0857

Part no.	Outside Diameter	Inside Diameter	Wire Diameter	Free Length	Minimum Working Length	Total Coils	Spring Rate Kg/mm
MMC 477	15.00	11.60	1.70	30	14.33	7 ³ / ₄	0.6173
MMC 478				40	18.28	10 ¹ / ₄	0.4303
MMC 479				50	22.10	12 ¹ / ₂	0.3380
MMC 480				60	25.93	14 ³ / ₄	0.2784
MMC 481				70	29.75	17	0.2366
MMC 482				80	33.58	19 ¹ / ₄	0.2057
MMC 483				10	41.23	23 ³ / ₄	0.1632
MMC 484				120	48.88	28 ¹ / ₄	0.1352
MMC485				15.00	11.20	1.90	30
MMC486	40	20.90	10 ¹ / ₂				0.6819
MMC487	50	25.65	13				0.5270
MMC488	60	29.96	15 ¹ / ₄				0.4375
MMC489	70	34.68	17 ³ / ₄				0.3680
MMC490	80	39.18	20				0.3220
MMC491	10	48.45	25				0.2520
MMC492	120	57.48	29 ³ / ₄				0.2088
MMC 493	15.00	10.76	2.12				30
MMC 494				40	23.85	10 ³ / ₄	1.0804
MMC 495				50	29.15	13 ¹ / ₄	0.8403
MMC 496				60	34.45	15 ³ / ₄	0.6875
MMC 497				70	39.75	18 ¹ / ₄	0.5817
MMC 498				80	45.05	20 ³ / ₄	0.5041
MMC 499				10	55.65	25 ³ / ₄	0.398
MMC 500				120	66.00	30 ¹ / ₂	0.3317
MMC 501				16.00	12.80	1.60	40
MMC 502	50	18.40	11				0.2438
MMC 503	60	21.60	13				0.1995
MMC 504	70	24.87	14 ³ / ₄				0.1721
MMC 505	80	27.77	16 ³ / ₄				0.1488
MMC 506	100	34.00	20 ³ / ₄				0.1170
MMC 507	120	40.35	24 ¹ / ₂				0.0975
MMC 508	140	46.40	28 ¹ / ₂				0.0828
MMC 509	16.00	12.40	1.80				40
MMC 510				50	22.05	11 ³ / ₄	0.5688
MMC 511				60	25.71	13 ³ / ₄	0.4664
MMC 512				70	29.70	16	0.3953
MMC 513				80	33.31	18	0.3430
MMC 514				100	40.95	22 ¹ / ₄	0.2712
MMC 515				120	48.60	26 ¹ / ₂	0.2242
MMC 516				140	56.25	30 ³ / ₄	0.1911
MMC 517				16.00	12.00	2.00	40
MMC 518	50	25.50	12 ¹ / ₄				0.5688
MMC 519	60	30.00	14 ¹ / ₂				0.4664
MMC 520	70	34.50	16 ³ / ₄				0.3953
MMC 521	80	39.00	19				0.3430
MMC 522	100	48.00	23 ¹ / ₂				0.2712
MMC 523	120	57.00	28				0.2242
MMC 524	140	66.00	32 ¹ / ₂				0.1911

Part no.	Outside Diameter	Inside Diameter	Wire Diameter	Free Length	Minimum Working Length	Total Coils	Spring Rate Kg/mm
MMC 525	16.00	11.52	2.24	40	23.66	10	1.2079
MMC 526				50	29.12	12½	0.9203
MMC 527				60	34.16	14¾	0.7579
MMC 528				70	39.35	17	0.6442
MMC 529				80	44.80	19½	0.5522
MMC 530				100	55.04	24	0.4392
MMC 531				120	65.52	28¾	0.3612
MMC 532				140	76.16	33½	0.3067
MMC533				17.00	13.60	1.70	40
MMC534	50	18.70	10½				0.2743
MMC535	60	22.10	12½				0.2220
MMC536	70	25.08	14¼				0.1903
MMC537	80	28.10	16				0.1665
MMC538	100	34.43	19¾				0.1313
MMC539	120	40.80	23½				0.1084
MMC540	140	47.18	27¼				0.0923
MMC 541	17.00	13.20	1.90				40
MMC 542				50	22.33	11¼	0.4091
MMC 543				60	26.313	13¼	0.3364
MMC 544				70	29.93	15¼	0.2856
MMC 545				80	33.73	17¼	0.2482
MMC 546				100	41.33	21¼	0.1966
MMC 547				120	48.93	25¼	0.1627
MMC 548				140	56.53	29¼	0.1389
MMC 549				17.00	12.76	2.12	40
MMC 550	50	25.44	11½				0.6453
MMC 551	60	30.21	13¾				0.5217
MMC 552	70	34.45	15¾				0.4458
MMC 553	80	39.22	18				0.3831
MMC 554	100	47.88	22				0.3065
MMC 555	120	56.80	26¼				0.2528
MMC 556	140	65.72	30½				0.2151
MMC 557	17.00	12.28	2.36				40
MMC 558				50	28.91	11¾	1.0139
MMC 559				60	34.22	14	0.8238
MMC 560				70	39.53	16¼	0.6937
MMC 561				80	44.84	18½	0.5991
MMC 562				100	54.93	22¾	0.4764
MMC 563				120	65.70	27	0.3954
MMC 564				140	75.92	31½	0.3351
MMC 565				18.00	14.40	1.80	40
MMC 566	50	19.00	10				0.3086
MMC 567	60	22.18	11¾				0.2532
MMC 568	70	25.39	13½				0.2147
MMC 569	80	28.80	15½				0.1828
MMC 570	100	35.10	19				0.1452
MMC 571	120	41.40	22½				0.1204
MMC 572	140	47.70	26				0.1028

Part no.	Outside Diameter	Inside Diameter	Wire Diameter	Free Length	Minimum Working Length	Total Coils	Spring Rate Kg/mm
MMC 573	18.00	14.00	2.00	40	18.50	8¾	0.5787
MMC 574				50	22.20	10½	0.4595
MMC 575				60	26.00	12½	0.3720
MMC 576				70	30.00	14½	0.3125
MMC 577				80	34.00	16½	0.2693
MMC 578				100	41.50	20¼	0.2140
MMC 579				120	49.00	24	0.1775
MMC 580				140	56.50	27¾	0.1517
MMC 581	18.00	13.52	2.24	40	21.28	9	0.9187
MMC 582				50	25.76	11	0.7146
MMC 583				60	30.24	13	0.5846
MMC 584				70	34.72	15	0.4947
MMC 585				80	39.20	17	0.4287
MMC 586				100	48.16	21	0.3384
MMC 587				120	57.12	25	0.2796
MMC 588				140	66.08	29	0.2381
MMC 589	18.00	13.00	2.50	40	24.38	9¼	1.4468
MMC 590				50	29.38	11¼	1.1340
MMC 591				60	34.38	13¼	0.9324
MMC 592				70	40.00	15½	0.7770
MMC 593				80	45.00	17½	0.6767
MMC 594				100	55.63	21¾	0.5311
MMC 595				120	66.25	26	0.4370
MMC 596				140	76.48	30	0.3746
MMC 597	19.00	15.20	1.90	40	16.15	8	0.4343
MMC 598				50	19.48	9¾	0.3362
MMC 599				60	22.60	11¼	0.2817
MMC 600				70	25.65	13	0.2369
MMC 601				80	28.98	14¾	0.2044
MMC 602				100	35.31	18	0.1628
MMC 603				120	41.80	21½	0.1336
MMC 604				140	48.00	24¾	0.1145
MMC 605	19.00	14.76	2.12	40	18.55	8¼	0.6719
MMC 606				50	22.55	10	0.5249
MMC 607				60	26.50	12	0.4199
MMC 608				70	30.21	13¾	0.3574
MMC 609				80	33.92	15½	0.3111
MMC 610				100	41.65	19	0.2470
MMC 611				120	49.29	22¾	0.2023
MMC 612				140	56.80	26¼	0.1731
MMC 613	19.00	14.28	2.36	40	21.28	8½	1.0357
MMC 614				50	25.96	10½	0.7920
MMC 615				60	30.47	12¼	0.6568
MMC 616				70	34.81	14¼	0.5496
MMC 617				80	39.53	16¼	0.4724
MMC 618				100	48.38	20	0.3740
MMC 619				120	57.33	23¾	0.3095
MMC 620				140	66.67	27¾	0.2614

Part no.	Outside Diameter	Inside Diameter	Wire Diameter	Free Length	Minimum Working Length	Total Coils	Spring Rate Kg/mm
MMC 621	19.00	13.70	2.65	40	24.52	8 ³ / ₄	1.6715
MMC 622				50	29.82	10 ³ / ₄	1.2894
MMC 623				60	35.12	12 ³ / ₄	1.0495
MMC 624				70	40.42	14 ³ / ₄	0.8849
MMC 625				80	45.72	16 ³ / ₄	0.7649
MMC 626				100	56.32	20 ³ / ₄	0.6017
MMC 627				120	66.92	24 ³ / ₄	0.4959
MMC 628				140	77.52	28 ³ / ₄	0.4217
MMC 629	20.00	16.00	2.00	40	16.50	7 ³ / ₄	0.4771
MMC 630				50	19.50	9 ¹ / ₄	0.3784
MMC 631				60	23.00	11	0.3048
MMC 632				70	26.00	12 ¹ / ₂	0.2612
MMC 633				80	29.50	14 ¹ / ₄	0.2239
MMC 634				100	36.00	17 ¹ / ₂	0.1769
MMC 635				120	42.00	20 ¹ / ₂	0.1482
MMC 636				140	48.50	23 ³ / ₄	0.1261
MMC 637	20.00	15.52	2.25	40	19.04	8	0.7490
MMC 638				50	22.96	9 ³ / ₄	0.5798
MMC 639				60	26.88	11 ¹ / ₂	0.4730
MMC 640				70	30.63	13	0.4085
MMC 641				80	34.36	14 ³ / ₄	0.3524
MMC 642				100	42.00	18 ¹ / ₄	0.2765
MMC 643				120	29.84	21 ³ / ₄	0.2275
MMC 644				140	57.68	25 ¹ / ₄	0.1933
MMC 645	20.00	15.00	2.50	40	21.88	8 ¹ / ₄	1.1661
MMC 646				50	26.30	10	0.9110
MMC 647				60	31.25	12	0.7288
MMC 648				70	35.63	13 ³ / ₄	0.6203
MMC 649				80	40.00	15 ¹ / ₂	0.5399
MMC 650				100	49.38	19 ¹ / ₄	0.4225
MMC 651				120	58.75	23	0.3470
MMC 652				140	67.50	26 ¹ / ₂	0.2975
MMC 653	20.00	14.40	2.80	40	24.69	8 ¹ / ₄	1.9327
MMC 654				50	30.10	10 ¹ / ₄	1.4642
MMC 655				60	35.50	12	1.2079
MMC 656				70	40.60	14	1.0066
MMC 657				80	46.20	16	0.8628
MMC 658				100	56.70	19 ³ / ₄	0.6805
MMC 659				120	67.32	23 ¹ / ₂	0.5618
MMC 660				140	78.16	27 ¹ / ₄	0.4784
MMC 661	22.00	17.52	2.24	50	20.72	8 ³ / ₄	0.4834
MMC 662				60	24.08	10 ¹ / ₄	0.3955
MMC 663				70	27.39	11 ¹ / ₂	0.3434
MMC 664				80	30.67	13	0.2966
MMC 665				100	37.21	16	0.2330
MMC 666				120	43.75	19	0.1919
MMC 667				140	50.4	22	0.1631
MMC 668				160	57.12	25	0.1418

Part no.	Outside Diameter	Inside Diameter	Wire Diameter	Free Length	Minimum Working Length	Total Coils	Spring Rate Kg/mm
MMC 669	22.00	17.00	2.50	50	23.75	9	0.7526
MMC 670				60	28.09	10½	0.6198
MMC 671				70	31.88	12¼	0.5140
MMC 672				80	35.89	13¾	0.4483
MMC 673				100	43.75	17	0.3512
MMC 674				120	51.88	20¼	0.2886
MMC 675				140	60.00	23½	0.2450
MMC 676				160	68.13	26¾	0.2128
MMC 677	22.00	16.40	2.80	50	27.30	9¼	1.1978
MMC 678				60	32.20	11	0.9649
MMC 679				70	37.10	12¾	0.8078
MMC 680				80	42.65	14¼	0.7089
MMC 681				100	51.10	17¾	0.5513
MMC 682				120	60.60	21	0.4570
MMC 683				140	70.00	24½	0.3859
MMC 684				160	79.40	27¾	0.3372
MMC 685	22.00	16.00	3.00	50	30.00	9½	1.5747
MMC 686				60	35.25	11¼	1.2767
MMC 687				70	40.15	12¾	1.0986
MMC 688				80	45.29	14½	0.9447
MMC 689				100	55.57	18	0.7381
MMC 690				120	66.00	21½	0.6056
MMC 691				140	76.50	25	0.5134
MMC 692				160	87.00	28½	0.4456
MMC 693	24.00	19.00	2.50	50	21.88	8¼	0.6288
MMC 694				60	25.22	9½	0.5240
MMC 695				70	28.75	11	0.4367
MMC 696				80	32.47	12¼	0.3834
MMC 697				100	39.38	15¼	0.2966
MMC 698				120	46.25	18	0.2456
MMC 699				140	53.13	20¾	0.2096
MMC 700				160	60.29	23½	0.1828
MMC 701	24.00	18.40	2.80	50	25.20	8½	0.9924
MMC 702				60	29.40	10	0.8063
MMC 703				70	33.60	11½	0.6790
MMC 704				80	37.80	13	0.5864
MMC 705				100	46.20	16	0.4607
MMC 706				120	54.60	19	0.3794
MMC 707				140	63.00	22	0.3225
MMC 708				160	71.40	25	0.2804
MMC 709	24.00	18.00	3.00	50	27.75	8¾	1.2957
MMC 710				60	32.25	10¼	1.0602
MMC 711				70	36.75	10¾	0.8970
MMC 712				80	41.25	13¼	0.7774
MMC 713				100	51.00	16½	0.6032
MMC 714				120	60.00	19½	0.4997
MMC 715				140	69.75	22¾	0.4215
MMC 716				160	78.75	25¾	0.3682

Part no.	Outside Diameter	Inside Diameter	Wire Diameter	Free Length	Minimum Working Length	Total Coils	Spring Rate Kg/mm
MMC 717	24.00	17.30	3.35	50	30.99	8¾	2.1190
MMC 718				60	36.85	10½	1.6827
MMC 719				70	41.88	12	1.4302
MMC 720				80	47.74	13¾	1.2172
MMC 721				100	58.14	16¾	0.9696
MMC 722				120	68.91	20	0.7946
MMC 723				140	79.69	23¼	0.6730
MMC 724				160	90.46	26½	0.5837
MMC 725	26.00	20.70	2.65	50	21.87	7¾	0.6736
MMC 726				60	25.18	9	0.5533
MMC 727				70	28.49	10¼	0.4695
MMC 728				80	31.80	11½	0.4077
MMC 729				100	38.43	14	0.3227
MMC 730				120	45.72	16¾	0.2626
MMC 731				140	52.34	19¼	0.2245
MMC 732				160	58.97	21¾	0.1961
MMC 733	26.00	20.40	2.80	50	23.10	7¾	0.8560
MMC 734				60	26.94	9	0.7031
MMC 735				70	30.80	10½	0.5790
MMC 736				80	34.30	11¾	0.5048
MMC 737				100	42.14	14¼	0.4018
MMC 738				120	49.15	17	0.3281
MMC 739				140	56.70	19¾	0.2773
MMC 740				160	64.36	22¼	0.2430
MMC 741	26.00	19.70	3.15	50	26.78	8	1.3753
MMC 742				60	31.50	9½	1.1003
MMC 743				70	36.23	11	0.9169
MMC 744				80	40.27	12¼	0.8051
MMC 745				100	49.62	15¼	0.6228
MMC 746				120	58.28	18	0.5157
MMC 747				140	67.73	21	0.4343
MMC 748				160	76.39	23¾	0.3794
MMC 749	26.00	18.90	3.55	50	31.07	8¼	2.2460
MMC 750				60	36.39	9¾	1.8112
MMC 751				70	41.72	11¼	1.5176
MMC 752				80	47.04	12¾	1.3058
MMC 753				100	57.69	15¾	1.0208
MMC 754				120	68.34	18¾	0.8380
MMC 755				140	78.99	21¾	0.7107
MMC 756				160	89.64	24¾	0.6169
MMC 757	28.00	22.40	2.80	60	24.70	8¼	0.6145
MMC 758				70	28.00	9½	0.5121
MMC 759				80	31.50	10¾	0.4389
MMC 760				100	37.86	13	0.3491
MMC 761				120	44.80	15½	0.2845
MMC 762				140	51.10	17¾	0.2438
MMC 763				160	58.10	20¼	0.2104
MMC 764				180	64.40	22½	0.1873

Part no.	Outside Diameter	Inside Diameter	Wire Diameter	Free Length	Minimum Working Length	Total Coils	Spring Rate Kg/mm
MMC 765	28.00	21.70	3.15	60	29.14	8¾	0.9505
MMC 766				70	33.08	10	0.8020
MMC 767				80	37.02	11¼	0.6936
MMC 768				100	45.68	14	0.5346
MMC 769				120	53.55	16½	0.4424
MMC 770				140	61.43	19	0.3773
MMC 771				160	70.09	21¾	0.3248
MMC 772				180	77.97	24¼	0.2883
MMC 773				28.00	20.90	3.55	60
MMC 774	70	38.75	10¼				1.3170
MMC 775	80	43.49	11¾				1.1145
MMC 776	100	53.25	14½				0.8692
MMC 777	120	63.02	17¼				0.7125
MMC 778	140	72.78	20				0.6036
MMC 779	160	82.54	22¾				0.5236
MMC 780	180	92.30	25½				0.4623
MMC 781	28.00	20.50	3.75				60
MMC 782				70	41.25	10½	1.6315
MMC 783				80	46.88	12	1.3868
MMC 784				100	57.19	14¾	1.0877
MMC 785				120	67.50	17½	0.8947
MMC 786				140	77.82	20¼	0.7599
MMC 787				160	88.13	23	0.6603
MMC 788				180	98.57	25¾	0.5838
MMC 789				30.00	24.00	3.00	60
MMC 790	70	28.5	9				0.5878
MMC 791	80	32.25	10¼				0.4988
MMC 792	100	39	12½				0.3919
MMC 793	120	45.75	14¾				0.3227
MMC 794	140	52.5	17				0.2743
MMC 795	160	58.5	19				0.2420
MMC 796	180	65.25	21¼				0.2137
MMC 797	30.00	23.30	3.35				60
MMC 798				70	33.5	9½	0.8871
MMC 799				80	37.69	10¾	0.7604
MMC 800				100	45.37	13	0.6048
MMC 801				120	56.6	15½	0.4928
MMC 802				140	61.98	18	0.4158
MMC 803				160	69.52	20¼	0.3646
MMC 804				180	77.89	22¾	0.3206
MMC 805				30.00	22.90	3.55	60
MMC 806	70	36.39	9¾				1.1074
MMC 807	80	40.83	11				0.9536
MMC 808	100	49.70	13½				0.7463
MMC 809	120	58.17	15¾				0.6242
MMC 810	140	66.92	18¼				0.5281
MMC 811	160	75.68	20¾				0.4577
MMC 812	180	84.44	23¼				0.4039

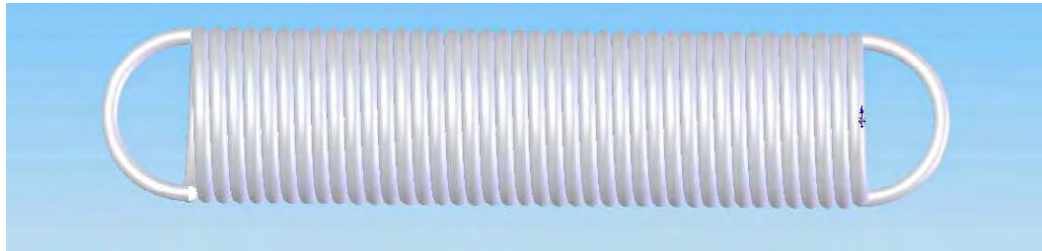

METRIC STEEL EXTENSION SPRINGS

FROM STOCK

When ordering it is necessary to specify the full spring reference number.

All orders subject to a Carriage Charge



Part no.	Outside Diameter	Wire Diameter	Free Length	No. of Working Coils	Maximum Working Length	Initial Tension	Spring Rate Kg/mm
MME 1	3.00	0.40	15	25	25.16	0.08	0.0619
MME 2			20	37	35.57		0.0404
MME 3			25	48½	45.97		0.030
MME 4			30	61	56.38		0.0238
MME 5			35	73½	66.79		0.0198
MME 6			40	86	77.19		0.0169
MME 7			50	111	98.00		0.0131
MME 8	4.00	0.50	20	25½	35.42	0.14	0.0571
MME 9			25	35½	46.47		0.0410
MME 10			30	45½	57.52		0.0320
MME 11			35	55½	68.58		0.0262
MME 12			40	65½	79.63		0.0222
MME 13			50	85	11.42		0.0171
MME 14			60	105	123.53		0.0138
MME 15	5.00	0.60	25	25	44.93	0.18	0.0608
MME 16			30	33½	56.70		0.0454
MME 17			40	50	79.86		0.0304
MME 18			50	66½	103.01		0.0228
MME 19			60	83	126.17		0.0183
MME 20			70	99½	149.32		0.0152
MME 21			80	116	172.48		0.0131
MME 22	6.00	0.80	30	23½	48.04	0.34	0.1252
MME 23			35	30	58.03		0.0981
MME 24			40	36	67.63		0.0817
MME 25			50	48½	87.23		0.0606
MME 26			60	61	106.83		0.0482
MME 27			70	73½	126.42		0.0400
MME 28			80	86	146.02		0.0342
MME 29	90	110½	184.82	0.0266			
MME 30	7.00	0.90	35	25½	58.24	0.44	0.1148
MME 31			40	31	68.26		0.0944
MME 32			50	42	88.28		0.0697
MME 33			60	53	108.32		0.0552
MME 34			70	64	128.34		0.0457
MME 35			80	75	148.37		0.0390
MME 36			100	97	188.43		0.0301
MME 37	120	119	228.49	0.0246			
MME 38	8.00	0.80	35	27	78.09	0.22	0.0410
MME 39			40	33	92.67		0.0336
MME 40			50	4	121.82		0.0246
MME 41			60	57	150.97		0.0194
MME 42			70	69½	180.92		0.0159
MME 43			80	81½	210.08		0.0136
MME 44			100	106	269.18		0.0104
MME 45	120	130½	328.27	0.0085			

Part no.	Outside Diameter	Wire Diameter	Free Length	No. of Working Coils	Maximum Working Length	Initial Tension	Spring Rate Kg/mm
MME 46	8.00	1.00	35	21	57.91	0.50	0.1403
MME 47			40	25½	67.82		0.1155
MME 48			50	35½	88.73		0.0830
MME 49			60	45	109.10		0.0654
MME 50			70	55	130.01		0.0535
MME 51			80	65	150.92		0.0453
MME 52			100	85	192.75		0.0346
MME 53			120	104½	234.03		0.0282
MME 54	10.00	1.25	40	18	64.42	0.75	0.2024
MME 55			50	26	85.27		0.1401
MME 56			60	34	106.13		0.1072
MME 57			70	42	126.99		0.0868
MME 58			80	50	147.84		0.0729
MME 59			100	66	189.55		0.0552
MME 60			120	82	321.26		0.0444
MME 61			140	98	272.97		0.0372
MME 62	12.00	1.50	50	19½	80.15	1.15	0.2268
MME 63			60	26	100.2		0.1701
MME 64			70	32½	120.25		0.1361
MME 65			80	39½	141.07		0.1119
MME 66			100	52½	181.17		0.0842
MME 67			120	66	222.05		0.0670
MME 68			140	79	262.14		0.0559
MME 69			160	92	302.24		0.0480
MME 70	14.00	1.70	60	21	99.07	1.36	0.2160
MME 71			70	26½	119.31		0.1711
MME 72			80	32½	140.47		0.1395
MME 73			100	43½	180.94		0.1042
MME 74			120	55	222.34		0.0824
MME 75			140	66½	263.73		0.0682
MME 76			160	78½	306.07		0.0578
MME 77			180	90	347.47		0.0504
MME 78	16.00	1.90	70	22½	118.31	1.65	0.2088
MME 79			80	27½	139.04		0.1708
MME 80			100	38	181.59		0.1236
MME 81			120	48½	224.13		0.0968
MME 82			140	59	266.69		0.0796
MME 83			160	69½	309.24		0.0676
MME 84			180	80	351.79		0.0587
MME 85			200	90½	394.32		0.0519

Part no.	Outside Diameter	Wire Diameter	Free Length	No. of Working Coils	Maximum Working Length	Initial Tension	Spring Rate Kg/mm
MME 86	20.00	2.00	80	22	156.34	1.30	0.1260
MME 87			100	32	211.03		0.0866
MME 88			120	42	265.74		0.0660
MME 89			140	52	320.42		0.0533
MME 90			160	62	375.13		0.0447
MME 91			180	72	429.82		0.0385
MME 92			200	81½	482.80		0.0340
MME 93			220	91½	537.50		0.0303
MME 94	20.00	2.50	80	18	121.07	3.20	0.4092
MME 95			100	26	159.33		0.2833
MME 96			120	34	197.59		0.2166
MME 97			140	42	235.85		0.1753
MME 98			160	50	274.10		0.1473
MME 99			180	58	312.36		0.1270
MME 100			200	66	350.62		0.1116
MME 101			220	74	388.88		0.0995
MME 102	24.00	2.50	100	23½	186.85	2.20	0.1690
MME 103			120	31	234.56		0.1281
MME 104			140	39	284.13		0.1018
MME 105			160	47	333.70		0.0845
MME 106			180	55	383.27		0.0722
MME 107			200	63	432.83		0.0630
MME 108			220	71	482.40		0.0559
MME 109			240	79	531.96		0.0502
MME 110	24.00	3.00	100	19	151.07	4.00	0.4652
MME 111			120	25½	188.55		0.3466
MME 112			140	32	226.02		0.2762
MME 113			160	38½	263.49		0.2296
MME 114			180	45	300.97		0.1964
MME 115			200	51½	338.44		0.1716
MME 116			220	58	375.92		0.1524
MME 117			240	64½	413.39		0.1370

TUBE CLIPS/BUTTON CLIPS

Manufactured from BS1449 CS70, heat treated and chemically blacked

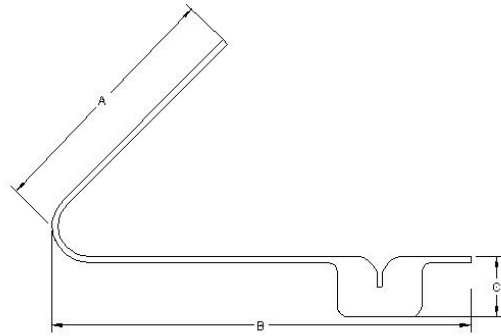

Strip Width & Thickness	A	B	C	Diameter of Button
0.250" x 0.020"	1.290"	1.290"	0.350"	0.225"
0.350" x 0.020"	1.275"	1.400"	0.400"	0.225"
0.375" x 0.028"	1.615"	1.630"	0.350"	0.310"

R. CLIPS (RETAINING CLIPS)

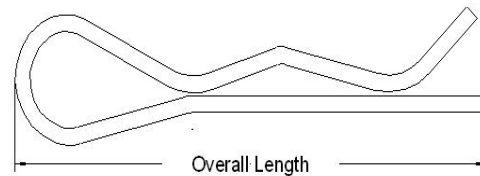
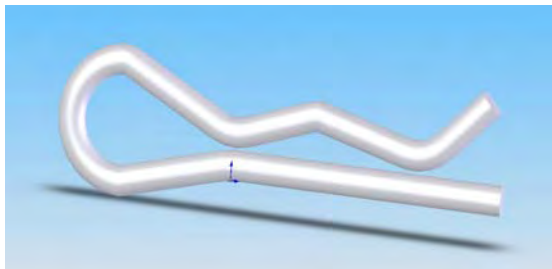

Wire Diameter

Overall Length

1.2mm	21.0mm
2.0mm	43.0mm
2.5mm	45.0mm
3.0mm	54.0mm
3.5mm	67.0mm
4.0mm	75.0mm
5.0mm	107.0mm
6.0mm	117.0mm
7.0mm	170.0mm

ALL R CLIPS ARE ZINC PLATED.

ALL SIZES ARE APPROXIMATE, SPECIAL SIZES CAN BE PRODUCED

Stock Range of Circlips/Plain Wire Rings

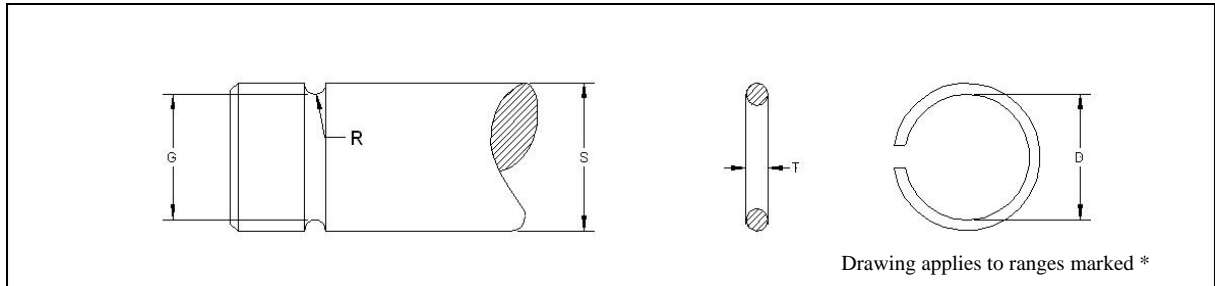

AS0900 'A' Range *

SIZE CODE	Shaft (S)			Groove (G)				Circlip (F)			
	S			G		r		D (max)		t	
	(frac)	(in)	(metric)	(in)	(mm)	(in)	(mm)	(in)	(mm)	(in)	(mm)
A025	1/4	0.250	6.35	0.232	5.89	0.0187	0.475	0.230	5.84	0.036	0.91
A037	3/8	0.375	9.53	0.349	8.86	0.024	0.610	0.345	8.76	0.043	1.09
A050	1/2	0.500	12.70	0.464	11.79	0.031	0.787	0.458	11.63	0.059	1.50
A062	5/8	0.625	15.88	0.581	14.76	0.039	0.991	0.575	14.61	0.072	1.83
A068	11/16	0.688	17.48	0.644	16.36	0.039	0.991	0.637	16.18	0.072	1.83
A075	3/4	0.750	19.05	0.698	17.73	0.044	1.118	0.690	17.53	0.085	2.16
A100	1	1.000	25.40	0.926	23.52	0.0605	1.537	0.917	23.29	0.118	3.00

AS0900 Range *

SIZE CODE	Shaft (S)			Groove (G)				Circlip (F)			
	S			G		r		D (max)		t	
	(frac)	(in)	(metric)	(in)	(mm)	(in)	(mm)	(in)	(mm)	(in)	(mm)
0012	1/8	0.125	3.18	0.111	2.82	0.013	0.330	0.110	2.79	0.022	0.56
0015	5/32	0.156	3.96	0.142	3.61	0.013	0.330	0.140	3.56	0.022	0.56
0018	3/16	0.187	4.75	0.174	4.42	0.013	0.330	0.172	4.37	0.022	0.56
0021	7/32	0.219	5.56	0.205	5.21	0.013	0.330	0.202	5.13	0.022	0.56
0025	1/4	0.250	6.35	0.232	5.89	0.016	0.406	0.230	5.84	0.028	0.71
0037	3/8	0.375	9.53	0.357	9.07	0.016	0.406	0.353	8.97	0.028	0.71
0043	7/16	0.438	11.13	0.416	10.57	0.020	0.508	0.412	10.46	0.036	0.91
0050	1/2	0.500	12.70	0.474	12.04	0.024	0.610	0.468	11.89	0.043	1.09
0056	9/16	0.562	14.27	0.534	13.56	0.026	0.660	0.529	13.44	0.045	1.14
0062	5/8	0.625	15.88	0.593	15.06	0.028	0.711	0.587	14.91	0.051	1.30
0068	11/16	0.688	17.48	0.656	16.66	0.028	0.711	0.649	16.48	0.051	1.30
0075	3/4	0.750	19.05	0.714	18.14	0.031	0.787	0.706	17.93	0.059	1.50
0087	7/8	0.875	22.23	0.831	21.11	0.039	0.991	0.823	20.90	0.072	1.83
0093	15/16	0.938	23.83	0.894	22.71	0.039	0.991	0.885	22.48	0.072	1.83
0106	1.1/16	1.062	26.97	1.011	25.68	0.044	1.118	1.000	25.40	0.085	2.16
0118	1.3/16	1.188	30.18	1.126	28.60	0.052	1.321	1.114	28.30	0.100	2.54
0137	1.3/8	1.375	34.93	1.295	32.89	0.069	1.753	1.281	32.54	0.130	3.30

AS1000 Range *

SIZE CODE	Shaft (S)			Groove (G)				Circlip (F)			
	S			G		r		D (max)		t	
	(frac)	(in)	(mm)	(in)	(mm)	(in)	(mm)	(in)	(mm)	(in)	(mm)
0012	1/8	0.125	3.18	0.113	2.87	0.0065	0.165	0.110	2.79	0.012	0.30
0025	1/4	0.250	6.35	0.228	5.79	0.0115	0.292	0.221	5.61	0.022	0.56
0031	5/16	0.312	7.92	0.290	7.37	0.0115	0.292	0.281	7.14	0.022	0.56
0034	11/32	0.344	8.74	0.322	8.18	0.0115	0.475	0.312	7.92	0.022	0.56
0037	3/8	0.375	9.53	0.339	8.61	0.0187	0.475	0.329	8.36	0.036	0.91
0040	13/32	0.406	10.31	0.370	9.40	0.0187	0.475	0.359	9.12	0.036	0.91
0043	7/16	0.438	11.13	0.402	10.21	0.0187	0.475	0.39	9.91	0.036	0.91
0046	15/32	0.469	11.91	0.433	11.00	0.0187	0.475	0.42	10.67	0.036	0.91
0050	1/2	0.500	12.70	0.452	11.48	0.2500	6.350	0.438	11.13	0.048	1.22
0056	9/16	0.562	14.27	0.514	13.06	0.2500	6.350	0.498	12.65	0.048	1.22
0062	5/8	0.625	15.88	0.577	14.66	0.2500	6.350	0.56	14.22	0.048	1.22
0068	11/16	0.688	17.48	0.640	16.26	0.2500	6.350	0.621	15.77	0.048	1.22
0075	3/4	0.750	19.05	0.686	17.42	0.0335	0.851	0.665	16.89	0.064	1.63
0081	13/16	0.812	20.62	0.748	19.00	0.0335	0.851	0.726	18.44	0.064	1.63
0087	7/8	0.875	22.23	0.811	20.60	0.0335	0.851	0.786	19.96	0.064	1.63
0093	15/16	0.938	23.83	0.874	22.20	0.0335	0.851	0.848	21.54	0.064	1.63
0100	1	1.000	25.40	0.936	23.77	0.0335	0.851	0.908	23.06	0.064	1.63
0106	1.1/16	1.062	26.97	0.982	24.94	0.0415	1.054	0.953	24.21	0.080	2.03
0112	1.1/8	1.125	28.58	1.045	26.54	0.0415	1.054	1.012	25.70	0.080	2.03
0125	1.1/4	1.250	31.75	1.170	29.72	0.0415	1.054	1.135	28.83	0.080	2.03
0137	1.3/8	1.375	34.93	1.295	32.89	0.0415	1.054	1.258	31.95	0.080	2.03
0150	1.1/2	1.500	38.10	1.420	36.07	0.0415	1.054	1.38	35.05	0.080	2.03
0162	1.5/8	1.625	41.28	1.545	39.24	0.0415	1.054	1.5	38.10	0.080	2.03
0175	1.3/4	1.750	44.45	1.670	42.42	0.0415	1.054	1.621	41.17	0.080	2.03
0187	1.7/8	1.875	47.63	1.771	44.98	0.0545	1.384	1.72	43.69	0.104	2.64
0200	2	2.000	50.80	1.896	48.16	0.0545	1.384	1.84	46.74	0.104	2.64
0212	2.1/8	2.125	53.98	2.021	51.33	0.0545	1.384	1.96	49.78	0.104	2.64
0237	2.3/8	2.375	60.33	2.271	57.68	0.0545	1.384	2.203	55.96	0.104	2.64
0250	2.1/2	2.500	63.50	2.396	60.86	0.0545	1.384	2.324	59.03	0.104	2.64
0262	2.5/8	2.625	66.68	2.497	63.42	0.0665	1.689	2.425	61.60	0.128	3.25
0300	3	3.000	76.20	2.872	72.95	0.0665	1.689	2.785	70.74	0.128	3.25

AS1700 Range **

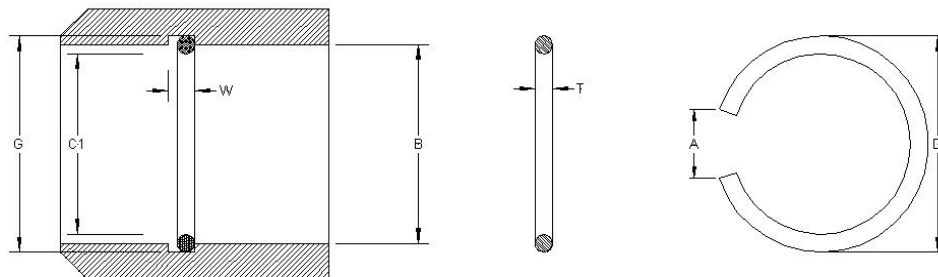

Drawing applies to ranges marked **

SIZE CODE	Bore (B)		Groove (G)				Circlip (F)							
	B		G		W		D (min)		T		C1		A	
	(in)	(mm)	(in)	(mm)	(in)	(mm)	(in)	(mm)	(in)	(mm)	(in)	(mm)	(in)	(mm)
0100	0.39	10	0.44	11.05	0.039	1.0	0.465	11.8	0.035	0.9	0.350	8.9	0.276	7.0
0120	0.47	12	0.52	13.13	0.043	1.1	0.547	13.9	0.039	1.0	0.425	10.8	0.276	7.0
0125	0.49	13	0.54	13.64	0.043	1.1	0.567	14.4	0.039	1.0	0.445	11.3	0.276	7.0
0130	0.51	13	0.56	14.15	0.043	1.1	0.587	14.9	0.039	1.0	0.465	11.8	0.276	7.0
0140	0.55	14	0.60	15.34	0.051	1.3	0.634	16.1	0.047	1.2	0.496	12.6	0.295	7.5
0150	0.59	15	0.64	16.36	0.051	1.3	0.673	17.1	0.047	1.2	0.535	13.6	0.295	7.5
0160	0.63	16	0.68	17.35	0.051	1.3	0.713	18.1	0.047	1.2	0.575	14.6	0.295	7.5
0170	0.67	17	0.73	18.54	0.059	1.5	0.760	19.3	0.055	1.4	0.602	15.3	0.315	8.0
0175	0.69	18	0.75	19.05	0.059	1.5	0.787	20.0	0.055	1.4	0.622	15.8	0.354	9.0
0180	0.71	18	0.77	19.56	0.059	1.5	0.807	20.5	0.055	1.4	0.642	16.3	0.354	9.0
0190	0.75	19	0.81	20.55	0.059	1.5	0.846	21.5	0.055	1.4	0.681	17.3	0.354	9.0
0200	0.79	20	0.85	21.54	0.059	1.5	0.886	22.5	0.055	1.4	0.720	18.3	0.354	9.0
0210	0.83	21	0.90	22.76	0.067	1.7	0.933	23.7	0.063	1.6	0.752	19.1	0.374	9.5
0220	0.87	22	0.94	23.75	0.067	1.7	0.972	24.7	0.063	1.6	0.791	20.1	0.374	9.5
0240	0.94	24	1.02	25.96	0.075	1.9	1.063	27.0	0.071	1.8	0.862	21.9	0.394	10.0
0250	0.98	25	1.06	26.95	0.075	1.9	1.098	27.9	0.071	1.8	0.902	22.9	0.394	10.0
0280	1.10	28	1.19	30.15	0.083	2.1	1.224	31.1	0.079	2.0	1.012	25.7	0.433	11.0
0300	1.18	30	1.27	32.15	0.083	2.1	1.303	33.1	0.079	2.0	1.091	27.7	0.433	11.0
0320	1.26	32	1.34	34.15	0.083	2.1	1.382	35.1	0.079	2.0	1.169	29.7	0.433	11.0
0340	1.34	34	1.42	36.17	0.083	2.1	1.461	37.1	0.079	2.0	1.248	31.7	0.433	11.0

Extra-Light Load Springs

VL-SERIES

RECTANGULAR WIRE

COLOUR CODE LIGHT GREEN

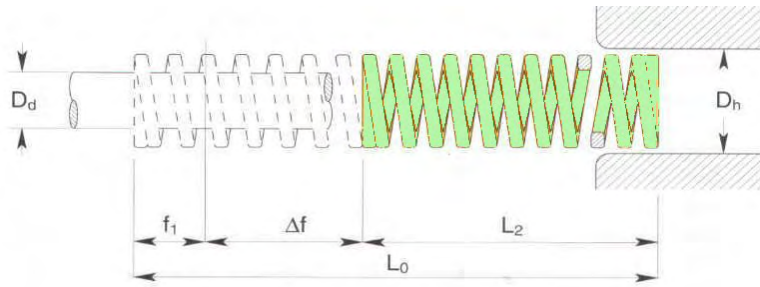

D_H	D_d	L_0	Catalogue No.	R	A		B		C		D	
					25% L_0		30% L_0		37.5% L_0		f_b	
mm	mm	mm		N/mm	N	mm	N	mm	N	mm	N	mm
20	10	25	VL20-025	29.4	221	7.5	294	10.0	368	12.5	409	13.9
		32	VL20-032	22.6	217	9.6	289	12.8	362	16.0	411	18.2
		38	VL20-038	18.6	212	11.4	283	15.2	353	19.0	409	22.0
		44	VL20-044	15.7	207	13.2	276	17.6	345	22.0	405	25.8
		51	VL20-051	13.7	210	15.3	279	20.4	349	25.5	415	30.3
		64	VL20-064	11.3	217	19.2	289	25.6	362	32.0	440	38.9
		76	VL20-076	9.8	223	22.8	298	30.4	372	38.0	461	47.0
		89	VL20-089	8.3	222	26.7	295	35.6	369	44.5	462	55.7
		102	VL20-102	7.4	226	30.6	302	40.8	377	51.0	475	64.2
		115	VL20-115	6.4	221	34.5	294	46.0	368	57.5	467	72.9
		127	VL20-127	5.9	225	38.1	300	50.8	375	63.5	476	80.7
		139	VL20-139	5.4	225	41.7	300	55.6	375	69.5	477	88.4
		152	VL20-152	4.9	223	45.6	298	60.8	372	76.0	474	96.7
		305	VL20-305	2.5	229	91.5	305	122.0	381	152.5	491	196.3
25	12.5	25	VL25-025	54	404	7.5	539	10.0	674	12.5	695	12.9
		32	VL25-032	42.2	405	9.6	540	12.8	675	16.0	726	17.2
		38	VL25-038	35.8	408	11.4	544	15.2	680	19.0	741	20.7
		44	VL25-044	31.4	414	13.2	553	17.6	691	22.0	766	24.4
		51	VL25-051	27.0	413	15.3	551	20.4	689	25.5	770	28.5
		64	VL25-064	21.6	415	19.2	553	25.6	691	32.0	788	36.5
		76	VL25-076	18.1	413	22.8	550	30.4	688	38.0	795	43.9
		89	VL25-089	15.2	406	26.7	541	35.6	676	44.5	781	51.4
		102	VL25-102	13.2	404	30.6	539	40.8	673	51.0	783	59.3
		115	VL25-115	11.8	407	34.5	543	46.0	679	57.5	793	67.2
		127	VL25-127	10.6	404	38.1	538	50.8	673	63.5	789	74.4
		139	VL25-139	9.6	400	41.7	534	55.6	667	69.5	783	81.6
		152	VL25-152	8.8	401	45.6	535	60.8	669	76.0	788	89.5
		178	VL25-178	7.6	406	53.4	541	71.2	676	89.0	801	105.4
203	VL25-203	6.7	408	60.9	544	81.2	680	101.5	809	120.7		
305	VL25-305	4.4	403	91.5	537	122.0	671	152.5	803	182.4		

Note: 1 N = 0,102 Kg (Force)

D _H	D _d	L ₀	Catalogue No.	R	A		B		C		D	
					25% L ₀		30% L ₀		37.5% L ₀		f _b	
mm	mm	mm		N/mm	N	mm	N	mm	N	mm	N	mm
32	16	38	VL32-038	43.1	491	11.4	655	15.2	819	19.0	858	19.9
		44	VL32-044	37.3	492	13.2	656	17.6	821	22.0	877	23.5
		51	VL32-051	32.4	496	15.3	661	20.4	826	25.5	894	27.6
		64	VL32-064	25.5	490	19.2	653	25.6	816	32.0	898	35.2
		76	VL32-076	21.6	492	22.8	657	30.4	821	38.0	916	42.4
		89	VL32-089	18.1	483	26.7	644	35.6	805	44.5	905	50.0
		102	VL32-102	15.7	480	30.6	641	40.8	801	51.0	904	57.6
		115	VL32-115	14.2	490	34.5	653	46.0	817	57.5	93	65.5
		127	VL32-127	12.7	484	38.1	645	50.8	806	63.5	921	72.5
		139	VL32-139	11.6	484	41.7	645	55.6	806	69.5	921	79.4
		152	VL32-152	10.6	483	45.6	644	60.8	806	76.0	925	87.3
		178	VL32-178	9.0	481	43.4	641	71.2	801	89.0	926	102.9
		203	VL32-203	7.8	475	60.9	633	81.2	792	101.5	918	117.7
		254	VL32-254	6.4	488	76.2	650	101.6	713	127.0	948	148.1
305	VL32-305	5.3	485	91.5	647	122.0	808	152.5	945	178.3		
40	20	51	VL40-051	48.1	736	15.3	981	20.4	1227	25.5	1347	28.0
		64	VL40-064	39.2	753	19.2	1004	25.6	1254	32.0	1419	36.2
		76	VL40-076	33.3	759	22.8	1012	30.4	1265	38.0	1455	43.7
		89	VL40-089	28.4	758	26.7	1011	35.6	1264	44.5	1468	51.7
		102	VL40-102	24.5	750	30.6	1000	40.8	1250	51.0	1465	59.8
		115	VL40-115	22.1	762	34.5	1017	46.0	1271	57.5	1501	67.9
		127	VL40-127	19.6	747	38.1	996	50.8	1245	63.5	1474	75.2
		139	VL40-139	17.7	738	41.7	984	55.6	1230	69.5	1458	82.4
		152	VL40-152	16.2	739	45.6	985	60.8	1231	76.0	1468	90.6
		178	VL40-178	13.7	732	53.4	975	71.2	1219	89.0	1459	106.5
		203	VL40-203	12.3	749	60.9	999	81.2	1248	101.5	1503	122.2
		254	VL40-254	9.8	747	76.2	996	101.6	1245	127.0	1505	153.6
305	VL40-305	8.3	759	91.5	1013	122.0	1266	152.5	1539	185.4		
50	25	64	VL50-064	86.3	1657	19.2	2209	25.6	2762	32.0	3029	35.1
		76	VL50-076	70.6	1610	22.8	2146	30.4	2683	38.0	2979	42.2
		89	VL50-089	59.8	1597	26.7	2129	35.6	2661	44.5	3008	50.3
		102	VL50-102	52.0	1591	30.6	2122	40.8	2652	51.0	3037	58.4
		115	VL50-115	46.1	1590	34.5	2121	46.0	2651	57.5	3047	66.1
		127	VL50-127	42.2	1608	38.1	2144	50.8	2680	63.5	3114	73.8
		139	VL50-139	38.2	1593	41.7	2124	55.6	2655	69.5	3090	80.9
		152	VL50-152	34.3	1564	45.6	2085	60.8	2607	76.0	3053	89.0
		178	VL50-178	29.4	1570	53.4	2093	71.2	2617	89.0	3096	105.3
		203	VL50-203	25.5	1553	60.9	2071	81.2	2588	101.5	3075	120.6
		254	VL50-254	20.6	1570	76.2	2093	101.6	2616	127.0	3135	152.2
305	VL50-305	17.2	1574	91.5	2098	122.0	2623	152.5	3160	183.7		

Note: 1 N = 0,102 Kg (Force)

Light Load Springs

V-SERIES

RECTANGULAR WIRE

COLOUR CODE GREEN

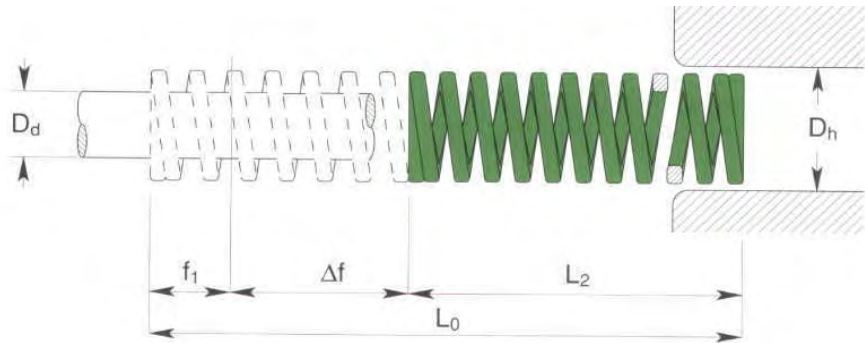

D _H	D _d	L ₀	Catalogue No.	R	A		B		C		D	
					25% L ₀		30% L ₀		40% L ₀		f _b	
mm	mm	mm		N/mm	N	mm	N	mm	N	mm	N	mm
10	5	25	V10-025	10	63	6.3	75	7.5	100	10.0	135	13.5
		32	V10-032	8.5	68	8.0	82	9.6	109	12.8	149	17.5
		38	V10-038	6.8	65	9.5	78	11.4	103	15.2	141	20.8
		44	V10-044	6.0	66	11.0	79	13.2	106	17.6	143	23.9
		51	V10-051	5.0	64	12.8	77	15.3	102	20.4	145	28.9
		64	V10-064	4.3	69	16.0	83	19.2	110	25.6	155	36.1
		76	V10-076	3.2	61	19.0	73	22.8	97	30.4	138	43.2
		305	V10-305	1.1	84	76.3	101	91.5	134	122.0	197	178.7
12.5	6.3	25	V13-025	17.9	113	6.3	134	7.5	179	10.0	236	13.2
		32	V13-032	16.4	131	8.0	157	9.6	210	12.8	295	18.0
		38	V13-038	13.6	129	9.5	155	11.4	207	15.2	286	21.0
		44	V13-044	12.1	133	11.0	160	13.2	213	17.6	290	24.0
		51	V13-051	11.4	146	12.8	174	15.3	233	20.4	327	28.7
		64	V13-064	9.3	149	16.0	179	19.2	238	25.6	333	35.8
		76	V13-076	7.1	135	19.0	162	22.8	216	30.4	303	42.7
		89	V13-089	5.4	120	22.3	144	26.7	192	35.6	272	50.4
		102	V13-102	4.1	105	25.5	125	30.6	167	40.8	239	58.4
305	V13-305	1.4	107	76.3	128	91.5	171	122.0	241	172.0		
16	8	25	V16-025	23.4	147	6.3	176	7.5	234	10.0	295	12.6
		32	V16-032	22.9	183	8.0	220	9.6	293	12.8	376	16.4
		38	V16-038	19.3	183	9.5	220	11.4	293	15.2	380	19.7
		44	V16-044	17.1	188	11.0	226	13.2	301	17.6	385	22.5
		51	V16-051	15.7	201	12.8	240	15.3	320	20.4	413	26.3
		64	V16-064	10.7	171	16.0	205	19.2	274	25.6	356	33.3
		76	V16-076	10.0	190	19.0	228	22.8	304	30.4	402	40.2
		89	V16-089	8.6	192	22.3	230	26.7	306	35.6	409	47.6
		102	V16-102	7.8	199	25.5	239	30.6	318	40.8	432	55.4
		115	V16-115	6.6	190	28.8	228	34.5	304	46.0	401	60.8
305	V16-305	2.5	191	76.3	229	91.5	305	122.0	413	165.3		

D _H	D _d	L ₀	Catalog ue No.	R	A		B		C		D	
					25% L ₀		30% L ₀		40% L ₀		f _b	
mm	mm	mm		N/mm	N	mm	N	mm	N	mm	N	mm
20	10	25	V20-025	55.8	352	6.3	419	7.5	558	10.0	675	12.1
		32	V20-032	45.0	360	8.0	432	9.6	576	12.8	689	15.3
		38	V20-038	33.3	316	9.5	380	11.4	506	15.2	629	18.9
		44	V20-044	30.0	330	11.0	396	13.2	528	17.6	645	21.5
		51	V20-051	24.5	314	12.8	375	15.3	500	20.4	613	25.0
		64	V20-064	20.0	320	16.0	384	19.2	512	25.6	622	31.1
		76	V20-076	16.0	304	19	365	22.8	486	30.4	597	37.3
		89	V20-089	14.0	312	22.3	374	26.7	498	35.6	623	44.5
		102	V20-102	12.0	306	25.5	367	30.6	490	40.8	613	51.1
		115	V20-115	10.9	314	28.8	376	34.5	501	46.0	634	58.2
		127	V20-127	9.5	302	31.8	362	38.1	483	50.8	617	64.9
		139	V20-139	8.4	294	35.0	353	42.0	470	56.0	601	71.5
		152	V20-152	7.5	285	38.0	342	45.6	456	60.8	591	78.8
		305	V20-305	4.0	305	76.3	366	91.5	488	122.0	630	157.4
25	12.5	25	V25-025	100.0	630	6.3	750	7.5	1000	10.0	1190	11.9
		32	V25-032	80.3	642	8.0	771	9.6	1028	12.8	1285	16.0
		38	V25-038	62.0	589	9.5	707	11.4	942	15.2	1135	18.3
		44	V25-044	52.9	582	11.0	698	13.2	931	17.6	1132	21.4
		51	V25-051	44.0	563	12.8	673	15.3	898	20.4	1096	24.9
		64	V25-064	35.2	563	16.0	676	19.2	901	25.6	1105	31.4
		76	V25-076	28.0	532	19.0	638	22.8	851	30.4	1050	37.5
		89	V25-089	24.0	535	22.3	641	26.7	854	35.6	1044	43.5
		102	V25-102	21.1	538	25.5	646	30.6	861	40.8	1078	51.1
		115	V25-115	18.7	539	28.8	645	34.5	860	46.0	1086	58.1
		127	V25-127	16.7	531	31.8	636	38.1	848	50.8	1070	64.1
		139	V25-139	15.3	536	35.0	643	42.0	857	56.0	1077	70.4
		152	V25-152	14.0	532	38.0	638	45.6	851	60.8	1079	77.1
		178	V25-178	12.5	556	44.5	668	53.4	890	71.2	1164	93.1
203	V25-203	10.4	528	50.8	633	60.9	844	81.2	1068	102.7		
305	V25-305	7.0	534	76.3	641	91.5	854	122.0	1091	155.9		
32	16	38	V32-038	94.0	893	9.5	1072	11.4	1429	15.2	1720	18.3
		44	V32-044	79.0	875	11.0	1049	13.2	1399	17.6	1709	21.5
		51	V32-051	67.0	858	12.8	1025	15.3	1367	20.4	1709	25.5
		64	V32-064	53.0	848	16.0	1018	19.2	1357	25.6	1691	31.9
		76	V32-076	44.0	836	19.0	1003	22.8	1338	30.4	1698	38.6
		89	V32-089	37.2	830	22.3	993	26.7	1324	35.6	1730	46.5
		102	V32-102	32.0	816	25.5	979	30.6	1306	40.8	1702	53.2
		115	V32-115	29.0	835	28.8	1001	34.5	1334	46.0	1740	60.0
		127	V32-127	25.0	795	31.8	953	38.1	1270	50.8	1668	66.7
		139	V32-139	23.0	805	35.0	966	42.0	1288	56.0	1651	71.8
		152	V32-152	21.5	817	38.0	980	45.6	1307	60.8	1688	78.5
		178	V32-178	18.2	810	44.5	972	53.4	1296	71.2	1718	94.4
		203	V32-203	15.8	803	40.8	962	60.9	1283	81.2	1692	107.1
		254	V32-254	12.5	794	63.5	953	76.2	1270	101.6	1706	136.5
305	V32-305	10.3	786	76.3	942	91.5	1257	122.0	1676	162.7		

D _H	D _d	L ₀	Catalog ue No.	R	A		B		C		D	
					25% L ₀		30% L ₀		40% L ₀		f _b	
mm	mm	mm		N/mm	N	mm	N	mm	N	mm	N	mm
40	20	51	V40-051	92.0	1178	12.8	1408	15.3	1877	20.4	2346	25.5
		64	V40-064	73.0	1168	16.0	1402	19.2	1869	25.6	2292	31.4
		76	V40-076	63.0	1197	19.0	1436	22.8	1915	30.4	2381	37.8
		89	V40-089	51.0	1137	22.3	1362	26.7	1816	35.6	2259	44.3
		102	V40-102	43.0	1097	25.5	1316	30.6	1754	40.8	2180	50.7
		115	V40-115	39.6	1140	28.8	1366	34.5	1822	46.0	2301	58.1
		127	V40-127	37.0	1177	31.8	1410	38.1	1880	50.8	2390	64.6
		139	V40-139	32.0	1120	35.0	1344	42.0	1792	56.0	2243	70.1
		152	V40-152	28.0	1064	38.0	1277	45.6	1702	60.8	2145	76.6
		178	V40-178	25.5	1121	44.5	1346	53.4	1794	71.2	2278	90.4
		203	V40-203	22.7	1153	50.8	1382	60.9	1843	81.2	2324	102.4
		254	V40-254	17.0	1080	63.5	1295	76.2	1727	101.6	2190	128.8
		305	V40-305	14.8	1129	76.3	1354	91.5	1806	122.0	2310	156.1
50	25	64	V50-064	156	2496	16.0	2995	19.2	3994	25.6	4836	31.0
		76	V50-076	125	2375	19.0	2850	22.8	3800	30.4	4650	37.2
		89	V50-089	109	2431	22.3	2910	26.7	3880	35.6	4752	43.6
		102	V50-102	94.0	2397	25.5	2876	30.6	3835	40.8	4728	50.3
		115	V50-115	81.0	2333	28.8	2795	34.5	3726	46.0	4706	58.1
		127	V50-127	71.0	2258	31.8	2705	38.1	3607	50.8	4523	63.7
		139	V50-139	66.5	2328	35.0	2793	42.0	3724	56.0	4622	69.5
		152	V50-152	60.0	2280	38.0	2736	45.6	3648	60.8	4590	76.5
		178	V50-178	52.0	2314	44.5	2777	53.4	3702	71.2	4779	91.9
		203	V50-203	44.0	2235	50.8	2680	60.9	3573	81.2	4607	104.7
		254	V50-254	35.0	2223	63.5	2667	76.2	3556	101.6	4571	130.6
				305	V50-305	28.5	2175	76.3	2608	91.5	3477	122.0
63	388	76	V63-076	189	3591	19.0	4309	22.8	5746	30.4	6899	36.5
		89	V63-089	158	3523	22.3	4219	26.7	5625	35.6	6857	43.4
		102	V63-102	131	3341	25.5	4009	30.6	5345	40.8	6511	49.7
		115	V63-115	116	3341	28.8	4002	34.5	5336	46.0	6450	55.6
		127	V63-127	103	3275	31.8	3924	38.1	5232	50.8	6458	62.7
		152	V63-152	84.3	3203	38.0	3844	45.6	5125	60.8	6500	77.1
		178	V63-178	71.5	3182	44.5	3818	53.4	5091	71.2	6592	92.2
		203	V63-203	61.7	3134	50.8	3759	60.9	5010	81.2	6386	103.5
		254	V63-254	47	2985	63.5	3581	76.2	4775	101.6	6129	130.4
				305	V63-305	38.2	2915	76.3	3495	91.5	4660	122.0

Note: 1 N = 0,102 Kg (Force)

Medium Load Springs

B-SERIES

RECTANGULAR WIRE

COLOUR CODE BLUE

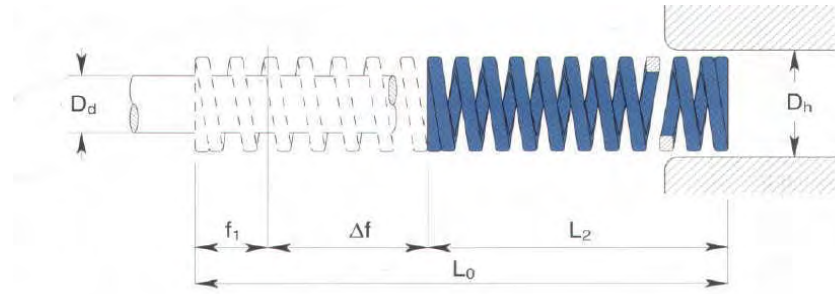

D_H	D_d	L_0	Catalogue No.	R	A		B		C		D	
					25% L_0	30% L_0	37.5% L_0	f_b				
mm	mm	mm		N/mm	N	mm	N	mm	N	mm	N	mm
10	5	25	B10-025	16.0	101	6.3	120	7.5	150	9.4	163	10.2
		32	B10-032	13.0	104	8.0	125	9.6	156	12.0	185	14.2
		38	B10-038	11.9	113	9.5	136	11.4	170	14.3	200	16.8
		44	B10-044	10.3	113	11.0	136	13.2	170	16.5	200	19.4
		51	B10-051	8.9	114	12.8	136	15.3	170	19.1	208	23.4
		64	B10-064	7.5	120	16.0	144	19.2	180	24.0	212	28.2
		76	B10-076	5.3	101	19.0	121	22.8	151	28.5	181	34.2
		305	B10-305	1.6	122	76.3	146	91.5	183	114.4	214	133.8
12.5	6.3	25	B13-025	30.0	189	6.3	225	7.5	282	9.4	357	11.9
		32	B13-032	24.8	198	8.0	238	9.6	298	12.0	402	16.2
		38	B13-038	21.4	203	9.5	244	11.4	306	14.3	400	18.7
		44	B13-044	18.5	204	11.0	244	13.2	305	16.5	394	21.3
		51	B13-051	15.5	198	12.8	237	15.3	296	19.1	397	25.6
		64	B13-064	12.1	194	16.0	232	19.2	290	24.0	392	32.4
		76	B13-076	10.2	194	19.0	233	22.8	291	28.5	398	39.0
		89	B13-089	8.4	187	22.3	224	26.7	281	33.4	386	45.9
		102	B13-102	6.3	161	25.5	193	30.6	241	38.3	329	52.3
		305	B13-305	2.1	160	76.3	192	91.5	240	114.4	320	152.5
16	8	25	B16-025	49.4	311	6.3	371	7.5	464	9.4	519	10.5
		32	B16-032	37.1	297	8.0	356	9.6	445	12.0	490	13.2
		38	B16-038	33.9	322	9.5	386	11.4	485	14.3	583	17.2
		44	B16-044	30.0	330	11.0	396	13.2	495	16.5	582	19.4
		51	B16-051	26.4	338	12.8	404	15.3	504	19.1	639	24.2
		64	B16-064	20.5	328	16.0	394	19.2	492	24.0	599	29.2
		76	B16-076	17.8	338	19.0	406	22.8	507	28.5	646	36.3
		89	B16-089	15.2	339	22.3	406	26.7	508	33.4	634	41.7
		102	B16-102	13.5	344	25.5	413	30.6	517	38.3	660	48.9
		115	B16-115	11.8	340	28.8	407	34.5	509	43.1	627	53.1
		305	B16-305	4.8	366	76.3	439	91.5	549	114.4	680	141.6

D _H	D _d	L ₀	Catalog ue No.	R	A		B		C		D	
					25% L ₀		30% L ₀		37.5% L ₀		f _b	
mm	mm	mm		N/mm	N	mm	N	mm	N	mm	N	mm
20	10	25	B20-025	98.0	617	6.3	735	7.5	921	9.4	1029	10.5
		32	B20-032	72.6	581	8.0	697	9.6	871	12.0	1009	13.9
		38	B20-038	56	532	9.5	638	11.4	801	14.3	930	16.6
		44	B20-044	47.5	523	11.0	627	13.2	784	16.5	893	18.8
		51	B20-051	41.7	534	12.8	638	15.3	796	19.1	963	23.1
		64	B20-064	32.3	517	16.0	620	19.2	775	24.0	888	27.5
		76	B20-076	25.1	477	19	572	22.8	715	28.5	848	33.8
		89	B20-089	22.0	491	22.3	587	26.7	735	33.4	873	39.7
		102	B20-102	19.8	505	25.5	606	30.6	758	38.3	937	47.3
		115	B20-115	18.1	521	28.8	624	34.5	780	43.1	950	52.5
		127	B20-127	16.6	528	31.8	632	38.1	790	47.6	945	56.9
		139	B20-139	15.1	529	35.0	634	42.0	793	52.5	938	62.1
		152	B20-152	13.2	500	38.0	600	45.6	750	57.0	889	67.6
		305	B20-305	6.1	465	76.3	558	91.5	698	114.4	875	143.4
25	12.5	25	B25-025	147	926	6.3	1103	7.5	1382	9.4	1499	10.2
		32	B25-032	118	944	8.0	1133	9.6	1416	12.0	1617	13.7
		38	B25-038	93.0	88	9.5	1060	11.4	1330	14.3	1460	15.7
		44	B25-044	80.8	4889	11.0	1067	13.2	1333	16.5	1471	18.2
		51	B25-051	68.6	878	12.8	1050	15.3	1310	19.1	1489	21.7
		64	B25-064	53.0	848	16.0	1018	19.2	1272	24.0	1378	26.0
		76	B25-076	43.2	821	19.0	985	22.8	1231	28.5	1395	32.3
		89	B25-089	38.2	852	22.3	1020	26.7	1276	33.4	1452	38.0
		102	B25-102	33.0	842	25.5	1010	30.6	1264	38.3	1419	43.0
		115	B25-115	28.0	806	28.8	966	34.5	1207	43.1	1361	48.6
		127	B25-127	25.9	824	31.8	987	38.1	1233	47.6	1391	53.7
		139	B25-139	23.2	812	35.0	974	42.0	1218	52.5	1378	59.4
		152	B25-152	20.8	790	38.0	948	45.6	1186	57.0	1327	63.8
		178	B25-178	17.8	792	44.5	951	53.4	1189	66.8	1363	76.6
203	B25-203	15.8	803	50.8	962	60.9	1202	76.1	1397	88.4		
305	B25-305	10.2	778	76.3	933	91.5	1167	114.4	1378	135.1		
32	16	38	B32-038	185	1758	9.5	2109	11.4	2646	14.3	3016	16.3
		44	B32-044	158	1738	11.0	2086	13.2	2607	16.5	2986	18.9
		51	B32-051	134	1715	12.8	2050	15.3	2559	19.1	3095	23.1
		64	B32-064	99.0	1584	16.0	1901	19.2	2376	24.0	2822	28.5
		76	B32-076	80.5	1530	19.0	1835	22.8	2294	28.5	2753	34.2
		89	B32-089	69.1	1541	22.3	1845	26.7	2308	33.4	2792	40.4
		102	B32-102	58.8	1499	25.5	1799	30.6	2252	38.3	2822	48.0
		115	B32-115	51.5	1483	28.8	1777	34.5	2220	43.1	2796	54.3
		127	B32-127	44.8	1425	31.8	1707	38.1	2132	47.6	2652	59.2
		139	B32-139	42.3	1481	35.0	1777	42.0	2221	52.5	2762	65.3
		152	B32-152	37.8	1436	38.0	1724	45.6	2155	57.0	2759	73.0
		178	B32-178	32.5	1446	44.5	1736	53.4	2171	66.8	2746	84.5
		203	B32-203	28.9	1468	40.8	1760	60.9	2199	76.1	2800	96.9
		254	B32-254	21.4	1359	63.5	1631	76.2	2039	95.3	2587	120.9
305	B32-305	18.3	1396	76.3	1674	91.5	2094	114.4	2688	146.9		

D _H	D _d	L ₀	Catalogue No.	R	A		B		C		D	
					25% L ₀		30% L ₀		37.5% L ₀		f _b	
mm	mm	mm		N/mm	N	mm	N	mm	N	mm	N	mm
40	20	51	B40-051	181.6	2324	12.8	2778	15.3	3469	19.1	3886	21.4
		64	B40-064	140.0	2240	16.0	2688	19.2	3360	24.0	3752	26.8
		76	B40-076	108.0	2052	19.0	2462	22.8	3078	28.5	3532	32.7
		89	B40-089	90.7	2023	22.3	2422	26.7	3029	33.4	3537	39.0
		102	B40-102	81.0	2066	25.5	2479	30.6	3102	38.3	3572	44.1
		115	B40-115	71.8	2068	28.8	2477	34.5	3095	43.1	3633	50.6
		127	B40-127	62.7	1994	31.8	2389	38.1	2985	47.6	3505	55.9
		139	B40-139	57.5	2013	35.0	2415	42.0	3019	52.5	3554	61.8
		152	B40-152	51.6	1961	38.0	2353	45.6	2941	57.0	3483	67.5
		178	B40-178	44.1	1962	44.5	2355	53.4	2946	66.8	3405	77.2
		203	B40-203	36.7	1864	50.8	2235	60.9	2793	76.1	3369	91.8
		254	B40-254	30.1	1911	63.5	2294	76.2	2869	95.3	3392	112.7
		305	B40-305	24.6	1877	76.3	2251	91.5	2814	114.4	3397	138.1
50	25	64	B50-064	209	3344	16.0	4013	19.2	5016	24.0	5894	28.2
		76	B50-076	168	3192	19.0	3830	22.8	4788	28.5	5863	34.9
		89	B50-089	140	3122	22.3	3738	26.7	4676	33.4	5488	39.2
		102	B50-102	119	3035	25.5	3641	30.6	4558	38.3	5629	47.3
		115	B50-115	106	3053	28.8	3657	34.5	4569	43.1	5576	52.6
		127	B50-127	97.0	3085	31.8	3696	38.1	4617	47.6	5801	59.8
		139	B50-139	87.0	3045	35.0	3654	42.0	4568	52.5	5664	65.1
		152	B50-152	80.0	3040	38.0	3648	45.6	4560	57.0	5664	70.8
		178	B50-178	69.5	3093	44.5	3711	53.4	4643	66.8	5852	84.2
		203	B50-203	59.8	3038	50.8	3642	60.9	4551	76.1	5771	96.5
		229	B50-229	50.9	2917	57.3	3497	68.7	4372	85.9	5523	108.5
		254	B50-254	43.9	2788	63.5	3345	76.2	4184	95.3	5347	121.8
		305	B50-305	38.6	2945	76.3	3532	91.5	4416	114.4	5666	146.8
63	388	76	B63-076	312	5928	19.0	7114	22.8	8892	28.5	9578	30.7
		89	B63-089	260	5798	22.3	6942	26.7	8684	33.4	9490	36.5
		102	B63-102	221	5636	25.5	6763	30.6	8464	38.3	9636	43.6
		115	B63-115	187	5386	28.8	6452	34.5	8060	43.1	9144	48.39
		127	B63-127	168	5342	31.8	6401	38.1	7997	47.6	9106	54.2
		152	B63-152	136	5168	38.0	6202	45.6	7752	57.0	8935	65.7
		178	B63-178	114	5073	44.5	6088	53.4	7615	66.8	8721	76.5
		203	B63-203	100	5080	50.8	6090	60.9	7610	76.1	8800	88
		229	B63-229	89.2	5111	57.3	6128	68.7	7662	85.9	9268	103.9
		254	B63-254	78.4	4978	63.5	5974	76.2	7472	95.3	8812	112.4
		305	B63-305	64.7	4937	76.3	5920	91.5	7402	114.4	8657	113.8

Note: 1 N = 0,102 Kg (Force)

Heavy Load Springs

R-SERIES

RECTANGULAR WIRE

COLOUR CODE RED

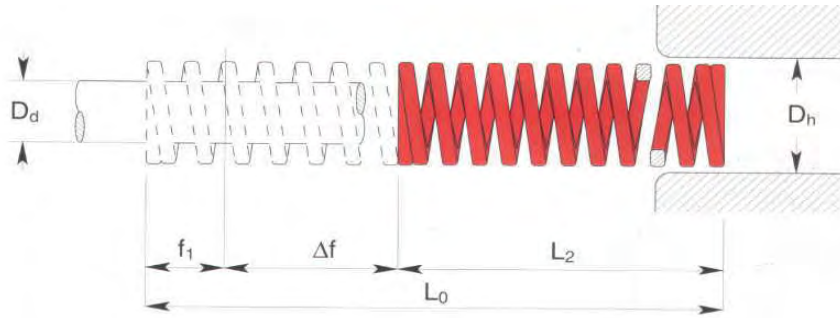

D_H	D_d	L_0	Catalogue No.	R	A		B		C		D	
					20% L_0	30% L_0	37.5% L_0	f_b				
mm	mm	mm		N/mm	N	mm	N	mm	N	mm	N	mm
10	5	25	R10-025	22.1	111	5.0	139	6.3	166	7.5	203	9.2
		32	R10-032	17.5	112	6.4	140	8.0	168	9.6	212	12.1
		38	R10-038	17.1	130	7.6	162	9.5	195	11.4	226	13.2
		44	R10-044	15.0	132	8.8	165	11.0	198	13.2	227	15.1
		51	R10-051	12.8	131	10.2	164	12.8	196	15.3	250	19.5
		64	R10-064	10.7	137	12.8	171	16.0	205	19.2	233	21.8
		76	R10-076	7.5	114	15.2	143	19.0	171	22.8	209	27.9
		305	R10-305	2.1	128	61.0	160	76.3	192	91.5	267	127.2
12.5	6.3	25	R13-025	42.1	211	5.0	265	6.3	316	7.5	413	9.8
		32	R13-032	33.2	212	6.4	266	8.0	319	9.6	452	13.6
		38	R13-038	29.3	223	7.6	278	9.5	334	11.4	428	14.6
		44	R13-044	24.6	216	8.8	271	11.0	325	13.2	445	18.1
		51	R13-051	19.6	200	10.2	251	12.8	300	15.3	437	22.3
		64	R13-064	15.0	192	12.8	240	16.0	288	19.2	410	27.3
		76	R13-076	13.2	201	15.2	251	19.0	301	22.8	437	33.1
		89	R13-089	11.4	203	17.8	254	22.3	304	26.7	443	38.9
		102	R13-102	8.4	171	20.4	214	25.5	257	30.6	368	43.8
305	R13-305	2.8	171	61.0	214	76.3	256	91.5	391	139.7		
16	8	25	R16-025	75.7	379	5.0	477	6.3	568	7.5	636	8.4
		32	R16-032	52.8	338	6.4	422	8.0	507	9.6	554	10.5
		38	R16-038	48.5	369	7.6	461	9.5	553	11.4	660	13.6
		44	R16-044	42.8	377	8.8	471	11.0	565	13.2	681	15.9
		51	R16-051	37.1	378	10.2	475	12.8	568	15.3	701	18.9
		64	R16-064	30.3	388	12.8	485	16.0	582	19.2	754	24.9
		76	R16-076	25.7	391	15.2	488	19.0	586	22.8	750	29.2
		89	R16-089	21.7	386	17.8	484	22.3	579	26.7	749	34.5
		102	R16-102	19.3	394	20.4	492	25.5	591	30.6	755	39.1
		115	R16-115	15.7	361	23.0	452	28.8	542	34.5	691	44
		305	R16-305	7.1	433	61.0	542	76.3	650	91.5	736	103.6

D _H	D _d	L ₀	Catalogue No.	R	A		B		C		D	
					20% L ₀		30% L ₀		37.5% L ₀		f _b	
mm	mm	mm		N/mm	N	mm	N	mm	N	mm	N	mm
20	10	25	R20-025	216.0	1080	5.0	1361	6.3	1620	7.5	1793	8.3
		32	R20-032	168.0	1075	6.4	1344	8.0	1613	9.6	1831	10.9
		38	R20-038	129.0	980	7.6	1226	9.5	1471	11.4	1613	12.5
		44	R20-044	112.0	986	8.8	1232	11.0	1478	13.2	1680	15.0
		51	R20-051	94.0	959	10.2	1203	12.8	1438	15.3	1654	17.6
		64	R20-064	72.1	923	12.8	1154	16.0	1384	19.2	1629	22.6
		76	R20-076	59.7	907	15.2	1134	19.0	1361	22.8	1642	27.5
		89	R20-089	50.5	899	17.8	1126	22.3	1348	26.7	1601	31.7
		102	R20-102	44.2	902	20.4	1127	25.5	1353	30.6	1658	37.5
		115	R20-115	38.4	883	23.0	1106	28.8	1325	34.5	1636	42.6
		127	R20-127	34.1	866	25.4	1084	31.8	1299	38.1	1552	45.5
		139	R20-139	31.0	868	28.0	1085	35.0	1302	42.0	1553	50.1
		152	R20-152	28.2	857	30.4	1072	38.0	1286	45.6	1574	55.8
		305	R20-305	15.0	915	61.0	1145	76.3	1373	91.5	1712	114.1
25	12.5	25	R25-025	375	1875	5.0	2363	6.3	2813	7.5	3188	8.5
		32	R25-032	297	1901	6.4	2376	8.0	2851	9.6	3267	11.0
		38	R25-038	219	1664	7.6	2081	9.5	2497	11.4	2759	12.6
		44	R25-044	187	1646	8.8	2057	11.0	2468	13.2	2768	14.8
		51	R25-051	156	1591	10.2	1997	12.8	2387	15.3	2792	17.9
		64	R25-064	123	1574	12.8	1968	16.0	2362	19.2	2841	23.1
		76	R25-076	99.0	1505	15.2	1881	19.0	2257	22.8	2604	26.3
		89	R25-089	84.0	1495	17.8	1873	22.3	2243	26.7	2562	30.5
		102	R25-102	73.0	1489	20.4	1862	25.5	2234	30.6	2723	37.3
		115	R25-115	65.0	1495	23.0	1872	28.8	2243	34.5	2724	41.9
		127	R25-127	57.7	1466	25.4	1835	31.8	2198	38.1	2666	46.2
		139	R25-139	52.7	1476	28.0	1845	35.0	2213	42.0	2598	49.3
		152	R25-152	47.8	1453	30.4	1816	38.0	2180	45.6	2662	55.7
		178	R25-178	41.0	1460	35.6	1825	44.5	2189	53.4	2669	65.1
203	R25-203	35.8	1453	40.6	1819	50.8	2180	60.9	2667	74.5		
305	R25-305	22.9	1397	61.0	1747	76.3	2095	91.5	2524	110.2		
32	16	38	R32-038	388	2949	7.6	3686	9.5	4423	11.4	4850	12.5
		44	R32-044	324	2851	8.8	3564	11	4277	13.2	4828	14.9
		51	R32-051	272	2774	10.2	3482	12.8	4162	15.3	4842	17.8
		64	R32-064	212	2714	12.8	3392	16.0	4070	19.2	4749	22.4
		76	R32-076	172	2614	15.2	3268	19.0	3922	22.8	4489	26.1
		89	R32-089	141	2510	17.8	3144	22.3	3765	26.7	4343	30.8
		102	R32-102	122	2489	20.4	3111	25.5	3733	30.6	4490	36.8
		115	R32-115	107	2461	23.0	3082	28.8	3692	34.5	4430	41.4
		127	R32-127	93.0	2362	25.4	2957	31.8	3543	38.1	4129	44.4
		139	R32-139	86.0	2408	28.0	3010	35.0	3612	42.0	4171	48.5
		152	R32-152	78.0	2371	30.4	2964	38.0	3557	45.6	4274	54.8
		178	R32-178	67.2	2392	35.6	2990	44.5	3588	53.4	4274	63.6
		203	R32-203	59.1	2399	40.6	3002	50.8	3599	60.9	4285	72.5
		254	R32-254	46.4	2357	50.8	2946	63.5	3536	76.2	4306	92.8
305	R32-305	38.0	2318	61.0	2899	76.3	3477	91.5	4248	111.8		

Note: 1 N = 0,102 Kg (Force)

D _H	D _d	L ₀	Catalogue No.	R	A		B		C		D	
					20% L ₀		25% L ₀		30% L ₀		f _b	
mm	mm	mm		N/mm	N	mm	N	mm	N	mm	N	mm
40	20	51	R40-051	350	3570	10.2	4480	12.8	5355	15.3	5950	17.0
		64	R40-064	269	3443	12.8	4304	16.0	5165	19.2	5891	21.9
		76	R40-076	219	3329	15.2	4161	19.0	4993	22.8	5847	26.7
		89	R40-089	190	3382	17.8	4237	22.3	5073	26.7	5947	31.3
		102	R40-102	163	3325	20.4	4157	25.5	4988	30.6	6047	37.1
		115	R40-115	142	3266	23.0	4090	28.8	4899	34.5	5822	41.0
		127	R40-127	128	3251	25.4	4070	31.8	4877	38.1	5952	46.5
		139	R40-139	115	3220	28.0	4025	35.0	4830	42.0	6107	53.1
		152	R40-152	105	3192	30.4	3990	38.0	4788	45.6	5891	56.1
		178	R40-178	89	3168	35.4	3961	44.5	4753	53.4	5999	67.4
		203	R40-203	77	3126	40.6	3912	50.8	4689	60.9	5867	76.2
		254	R40-254	61	3099	50.8	3874	63.5	4648	76.2	5868	96.2
		305	R40-305	51	3111	61.0	3891	76.3	4667	91.5	5855	114.8
50	25	64	R50-064	413	5286	12.8	6608	16.0	7930	19.2	9251	22.4
		76	R50-076	339	5153	15.2	6441	19.0	7729	22.8	8984	26.5
		89	R50-089	288	5126	17.8	6422	22.3	7690	26.7	9072	31.5
		102	R50-102	245	4998	20.4	6248	25.5	7497	30.6	9212	37.6
		115	R50-115	215	4945	23.0	6192	28.8	7418	34.5	9181	42.7
		127	R50-127	192	4877	25.4	6106	31.8	7315	38.1	9120	47.5
		139	R50-139	168	4704	28.0	5880	35.0	7056	42.0	8702	51.8
		152	R50-152	154	4682	30.4	5852	38.0	7022	45.6	8901	57.8
		178	R50-178	134	4770	35.6	5963	44.5	7156	53.4	9179	68.5
		203	R50-203	117	4750	40.6	5944	50.8	7125	60.9	9079	77.6
		254	R50-254	89	4521	50.8	5652	63.5	6782	76.2	8713	97.9
		305	R50-305	73	4453	61.0	5570	76.3	6680	91.5	8811	120.7
		63	388	76	R63-076	618	9394	15.2	11742	19.0	14090	22.8
89	R63-089			515	9167	17.8	11485	22.3	13751	26.7	15450	30.0
102	R63-102			438	8935	20.4	11169	25.5	13403	30.6	15374	35.1
115	R63-115			370	8510	23.0	10656	28.8	12765	34.5	13875	37.5
127	R63-127			333	8458	25.4	10589	31.8	12687	38.1	15285	45.9
152	R63-152			269	8178	30.4	10222	38.0	12266	45.6	15199	56.5
178	R63-178			226	80546	35.6	10057	44.5	12068	53.4	15097	66.8
203	R63-203			198	8039	40.6	10058	50.8	12058	60.9	15602	78.8
254	R63-254			155	7874	50.8	9843	63.5	11811	76.2	15763	101.7
305	R63-305			128	7808	61.0	9766	76.3	11712	91.5	15667	122.4

Note: 1 N = 0,102 Kg (Force)

Extra Heavy Load Springs

G-SERIES

RECTANGULAR WIRE

COLOUR CODE YELLOW

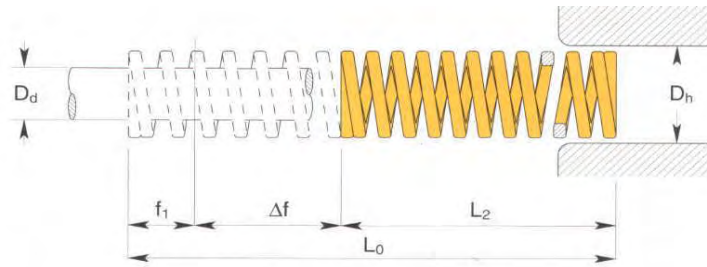

D_H	D_d	L_0	Catalogue No.	R	A		B		C		D	
					17% L_0		20% L_0		25% L_0		f_b	
mm	mm	mm		N/mm	N	mm	N	mm	N	mm	N	mm
10	5	25	G10-025	36.8	158	4.3	184	5.0	232	6.3	283	7.7
		32	G10-032	27.9	151	5.4	179	6.4	223	8.0	296	10.6
		38	G10-038	23.7	154	6.5	180	7.6	225	9.5	299	12.6
		44	G10-044	19.2	144	7.5	169	8.8	211	11.0	265	13.8
		51	G10-051	16.5	144	8.7	168	10.2	211	12.8	267	16.2
		64	G10-064	13.2	144	10.9	169	12.8	211	16.0	269	20.4
		76	G10-076	10.9	141	12.9	166	15.2	207	19.0	275	25.2
		305	G10-305	2.6	135	51.9	159	61.0	198	76.3	288	110.8
12.5	6.3	25	G13-025	58.5	252	4.3	293	5.0	369	6.3	474	8.1
		32	G13-032	43.9	237	5.4	281	6.4	351	8.0	435	9.9
		38	G13-038	36.0	234	6.5	274	7.6	342	9.5	464	12.9
		44	G13-044	30.3	227	7.5	267	8.8	333	11.0	427	14.1
		51	G13-051	26.2	228	8.7	267	10.2	335	12.8	456	17.4
		64	G13-064	21.2	231	10.9	271	12.8	339	16.0	445	21.0
		76	G13-076	17.1	221	12.9	260	15.2	325	19.0	451	26.4
		89	G13-089	14.5	219	15.1	258	17.8	323	22.3	457	31.5
		102	G13-102	12.7	220	17.3	259	20.4	324	25.5	457	36.0
		305	G13-305	4.3	223	51.9	262	61.0	328	76.3	479	111.3
16	8	25	G16-025	118	507	4.3	590	5.0	743	6.3	1003	8.5
		32	G16-032	89.0	481	5.4	570	6.4	712	8.0	979	11
		38	G16-038	72.1	469	6.5	548	7.6	685	9.5	952	13.2
		44	G16-044	60.9	457	7.5	536	8.8	670	11.0	895	14.7
		51	G16-051	52.3	455	8.7	533	10.2	669	12.8	926	17.7
		64	G16-064	41.2	449	10.9	527	12.8	659	16.0	902	21.9
		76	G16-076	34.1	440	12.9	518	15.2	648	19.0	948	27.8
		89	G16-089	29.5	445	15.1	525	17.8	658	22.3	920	31.2
		102	G16-102	25.6	443	17.3	522	20.4	653	25.5	970	37.9
		115	G16-115	22.4	439	19.6	515	23.0	645	28.8	997	44.5
		305	G16-305	8.4	436	51.9	512	61.0	641	76.3	953	113.5

D _H	D _d	L ₀	Catalog ue No.	R	A		B		C		D	
					17% L ₀		20% L ₀		25% L ₀		f _b	
mm	mm	mm		N/mm	N	mm	N	mm	N	mm	N	mm
20	10	25	G20-025	293	1260	4.3	1465	5.0	1846	6.3	2022	6.9
		32	G20-032	224	1210	5.4	1434	6.4	1792	8.0	2106	9.4
		38	G20-038	177	1151	6.5	134	7.6	1682	9.5	2124	12.0
		44	G20-044	149	1118	7.5	1311	8.8	1639	11.0	2012	13.5
		51	G20-051	128	1114	8.7	1306	10.2	1638	12.8	2074	16.2
		64	G20-064	99.0	1079	10.9	1267	12.8	1584	16.0	2099	21.2
		76	G20-076	81.7	1054	12.9	1242	15.2	1552	19.0	2018	24.7
		89	G20-089	69.5	1049	15.1	1237	17.8	1550	22.3	2002	28.8
		102	G20-102	60.6	1048	17.3	1236	20.4	1545	25.5	2109	34.8
		115	G20-115	53.0	1039	19.6	1219	23.0	1526	28.8	2067	39.0
		127	G20-127	47.5	1026	21.6	1207	25.4	1511	31.8	2043	43.0
		139	G20-139	43.0	1023	23.8	1204	28.0	1505	35.0	1948	45.3
		152	G20-152	39.0	1006	25.8	1186	30.4	1482	38.0	1966	50.4
		305	G20-305	21.2	1100	51.9	1293	61.0	1618	76.3	2194	103.5
25	12.5	25	G25-025	459.0	1974	4.3	2295	5.0	2892	6.3	3351	7.3
		32	G25-032	374.4	2022	5.4	2396	6.4	2995	8.0	4006	10.7
		38	G25-038	346.0	2249	6.5	2630	7.6	3287	9.5	4152	12.0
		44	G25-044	244.0	1830	7.5	2147	8.8	2684	11.0	3514	14.4
		51	G25-051	207.5	1805	8.7	2117	10.2	2656	12.8	3611	17.4
		64	G25-064	161.0	1755	10.9	2061	12.8	2576	16.0	3445	21.4
		76	G25-076	130.8	1687	12.9	1988	15.2	2485	19.0	3519	26.9
		89	G25-089	110.5	1669	15.1	1967	17.8	2464	22.3	3414	30.9
		102	G25-102	96.3	1666	17.3	1965	20.4	2456	25.5	3534	36.7
		115	G25-115	85.7	1680	19.6	1971	23.0	2468	28.8	3454	40.3
		127	G25-127	76.3	1648	21.6	1938	25.4	2426	31.8	3441	45.1
		139	G25-139	68.9	1640	23.8	1929	28.0	2412	35.0	3280	47.6
		152	G25-152	63.5	1638	25.8	1930	30.4	2413	38.0	3397	53.5
		178	G25-178	53.9	1633	30.3	1919	35.6	2399	44.5	3444	63.9
203	G25-203	47.0	1622	34.5	1908	40.6	2388	50.8	3299	70.2		
305	G25-305	30.9	1604	51.9	1885	61.0	2358	76.3	3402	110.1		
32	16	38	G32-038	528.2	3433	6.5	4014	7.6	4423	9.5	6021	11.4
		44	G32-044	424.4	3183	7.5	3735	8.8	4277	11.0	5814	13.7
		51	G32-051	353.0	3071	8.7	3601	10.2	4162	12.8	5507	15.6
		64	G32-064	269.2	2934	10.9	3446	12.8	4070	16.0	5384	20.0
		76	G32-076	218.5	2819	12.9	3321	15.2	3922	19.0	5331	24.4
		89	G32-089	180.3	2723	15.1	3209	17.8	3765	22.3	5355	29.7
		102	G32-102	155.0	2682	17.3	3162	20.4	3733	25.5	5441	35.1
		115	G32-115	140.0	2744	19.6	3220	23.0	3692	28.8	5460	39.0
		127	G32-127	124.0	2678	21.6	3150	25.4	3543	31.8	5307	42.8
		139	G32-139	112.3	2673	23.8	3144	28.0	3612	35.0	5458	48.6
		152	G32-152	102.0	2632	25.8	3101	30.4	3557	38.0	5345	52.4
		178	G32-178	88.2	2672	30.3	3140	35.6	3588	44.5	5371	60.9
		203	G32-203	76.0	2622	34.5	3086	40.6	3599	50.8	5259	69.2
		254	G32-254	60.8	2627	43.2	3089	50.8	3536	63.5	5356	88.1
305	G32-305	49.0	2543	51.9	2989	61.0	3477	76.3	5106	104.2		

Note: 1 N = 0,102 Kg (Force)

D _H	D _d	L ₀	Catalogue No.	R	A		B		C		D	
					20% L ₀		25% L ₀		30% L ₀		f _b	
					N	mm	N	mm	N	mm	N	mm
mm	mm	mm		N/mm								
40	20	51	G40-051	628	5464	8.7	6406	10.2	8038	12.8	9420	15.0
		64	G40-064	487	5308	10.9	6234	12.8	7792	16.0	9497	19.5
		76	G40-076	379	4889	12.9	5761	15.2	7201	19.0	8831	23.3
		89	G40-089	321	4847	15.1	5714	17.8	7158	22.3	8571	26.7
		102	G40-102	281	4861	17.3	5732	20.4	7166	25.5	9498	33.8
		115	G40-115	245	4802	19.6	5635	23.0	7056	28.8	8869	36.2
		127	G40-127	221	4774	21.6	5613	25.4	7028	31.8	8995	40.7
		139	G40-139	190	4522	23.8	5320	28.0	6650	35.0	8455	44.5
		152	G40-152	168	4334	25.8	5107	30.4	6384	38.0	8333	49.6
		178	G40-178	146	4424	30.3	5198	35.6	6497	44.5	8745	59.9
		203	G40-203	132	4554	34.5	5359	40.6	6706	50.8	8857	67.1
		254	G40-254	107	4622	43.2	5436	50.8	6795	63.5	9234	86.3
		305	G40-305	88	4557	51.9	5356	61.0	6699	76.3	9096	103.6
50	25	64	G50-064	709	7728	10.9	9075	12.8	11344	16.0	13684	19.3
		76	G50-076	572	7379	12.9	8694	15.2	10868	19.0	13842	24.2
		89	G50-089	475	7173	15.1	8455	17.8	10593	22.3	13300	28.0
		102	G50-102	405	7007	17.3	8262	20.4	10328	25.5	13568	33.5
		115	G50-115	352	6899	19.6	8096	23.0	10138	28.8	13587	38.6
		127	G50-127	316	6826	21.6	8026	25.4	10049	31.8	13082	41.4
		139	G50-139	274	6521	23.8	7672	28.0	9590	35.0	12960	47.3
		152	G50-152	239	6166	25.8	7266	30.4	9082	38.0	11998	50.2
		178	G50-178	215	6515	30.3	7654	35.6	9568	44.5	13137	61.1
		203	G50-203	187	6452	34.5	7592	40.6	9500	50.8	12660	67.7
		254	G50-254	153	6610	43.2	7772	50.8	9716	63.5	13311	87.0
		305	G50-305	127	6591	51.9	7747	61.0	9690	76.3	13132	103.4
		63	388	76	G63-076	952	12280	12.9	14470	15.2	*	*
89	G63-089			819	12360	15.1	14580	17.8	*	*	19040	20.0
102	G63-102			700	12110	17.3	14280	20.4	17850	25.5	21449	30.7
115	G63-115			620	12152	19.6	14260	23.0	17860	28.8	21640	34.9
127	G63-127			565	12204	21.6	14351	25.4	17967	31.8	21470	38.0
152	G63-152			458	11816	25.8	13923	30.4	17404	38.0	21618	47.2
178	G63-178			384	11635	30.3	13670	35.6	17088	44.5	21427	55.8
203	G63-203			337	11627	34.5	13682	40.6	17120	50.8	21838	64.8
254	G63-254			263	11362	43.2	13360	50.8	16701	63.5	22802	86.7
305	G63-305			218	11314	51.9	13298	61.0	16633	76.3	23043	105.7

Note: 1 N = 0,102 Kg (Force)

* Max. deflection = 20% L₀

How to find us.

Directions M5 North

Proceed to junction 1 on the M5, exit at junction 1. Take the 5th exit off the island on the A41 express way sign posted Wolverhampton & Dudley.

the next island and take the 2nd exit still following the signs for Wolverhampton & Dudley.

At the next island take the 2nd exit continuing on the A41.

As you approach the next island there is a large petrol station on the left-hand side, at the island take the 1st exit left and the immediate 1st turning right into Great Bridge.

Continue along Great Bridge Street, take 1st turning on the right hand side, which is Richmond Street South, turn into Richmond Street and take the next turning on the right, which is Elwell Street. Carry on down Elwell Street, KSM Springs is 100 yards on the left-hand side.

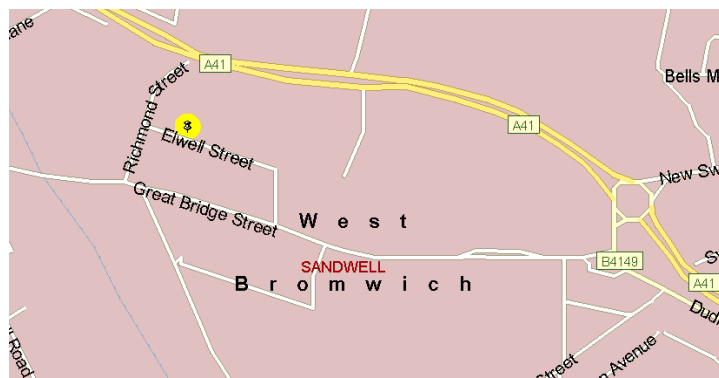
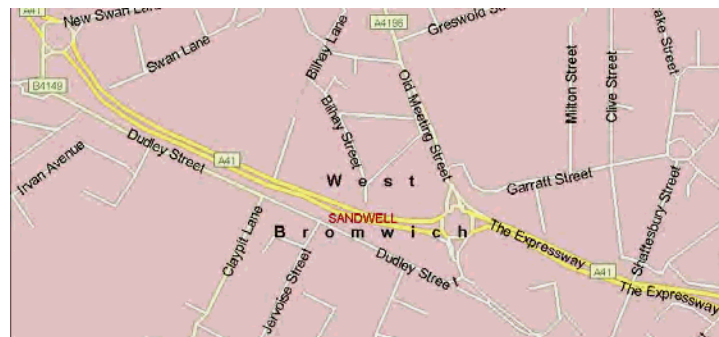

Have a safe Journey.

How to find us.

Directions M5 South

Proceed to junction 1 on the M5, exit at junction 1. Take the 2nd exit off the island on the A41 express way sign posted Wolverhampton & Dudley.

the next island and take the 2nd exit still following the signs for Wolverhampton & Dudley.

At the next island take the 2nd exit continuing on the A41.

As you approach the next island there is a large petrol station on the left-hand side, at the island take the 1st exit left and the immediate 1st turning right into Great Bridge.

Continue along Great Bridge Street, take 1st turning on the right hand side, which is Richmond Street South, turn into Richmond Street and take the next turning on the right, which is Elwell Street. Carry on down Elwell Street, KSM Springs is 100 yards on the left-hand side.

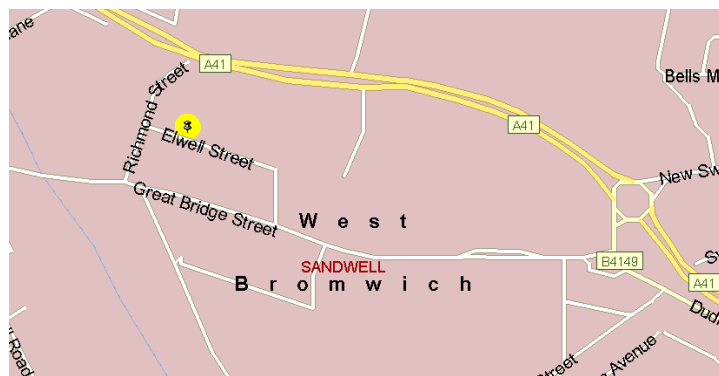
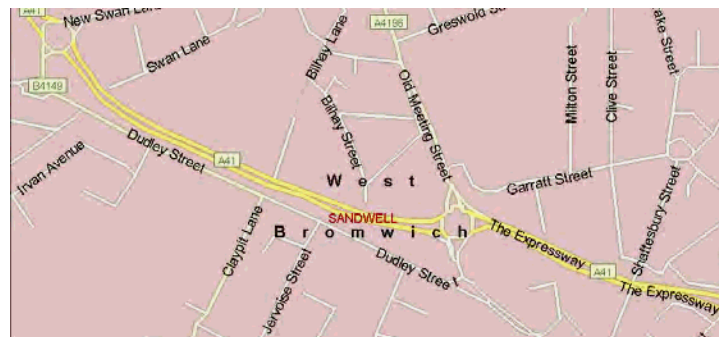
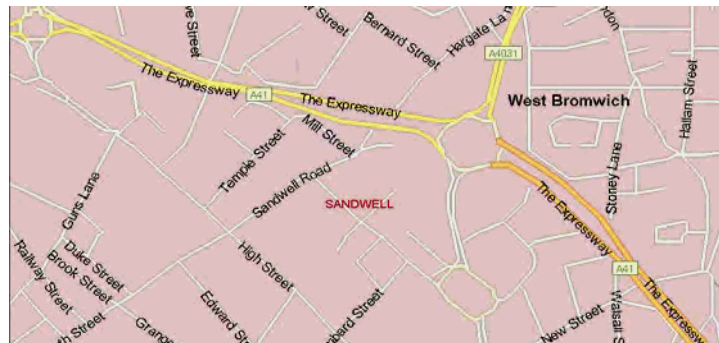

Have a safe Journey.